

# Ideal boundaries of pseudo-Anosov flows and uniform convergence groups, with connections and applications to large scale geometry

Sérgio R. Fenley <sup>\*†</sup>

April 18, 2011

**Abstract** – Given a general pseudo-Anosov flow in a closed three manifold, the orbit space of the lifted flow to the universal cover is homeomorphic to an open disk. We construct a natural compactification of this orbit space with an ideal circle boundary. If there are no perfect fits between stable and unstable leaves and the flow is not topologically conjugate to a suspension Anosov flow, we then show: The ideal circle of the orbit space has a natural quotient space which is a sphere. This sphere is a dynamical systems ideal boundary for a compactification of the universal cover of the manifold. The main result is that the fundamental group acts on the flow ideal boundary as a uniform convergence group. Using a theorem of Bowditch, this yields a proof that the fundamental group of the manifold is Gromov hyperbolic and it shows that the action of the fundamental group on the flow ideal boundary is conjugate to the action on the Gromov ideal boundary. This gives an entirely new proof that the fundamental group of a closed, atoroidal 3-manifold which fibers over the circle is Gromov hyperbolic. In addition with further geometric analysis, the main result also implies that pseudo-Anosov flows without perfect fits are quasigeodesic flows and that the stable/unstable foliations of these flows are quasi-isometric foliations. Finally we apply these results to (nonsingular) foliations: if a foliation is  $\mathbf{R}$ -covered or with one sided branching in an aspherical, atoroidal three manifold then the results above imply that the leaves of the foliation in the universal cover extend continuously to the sphere at infinity.

## 1 Introduction

The main purpose of this article is to analyse what information can be obtained about the asymptotic structure or large scale geometry of the universal cover of a manifold using only the dynamics of a pseudo-Anosov flow in the manifold. We introduce a dynamical systems ideal boundary for a large class of such flows and a corresponding compactification of the universal cover. The fundamental group acts on the flow ideal boundary and compactification with excellent dynamical properties. These objects are later shown to be strongly related to the large scale geometry of the manifolds and of the flows themselves. They also imply results about the geometry of foliations.

In three manifold theory, the universal cover of the manifold plays a crucial role. Topologically one is invariably interested that the universal cover is  $\mathbf{R}^3$  [Wa, He]. In terms of geometry, for example, Thurston showed that a large class of manifolds are hyperbolic [Th1, Th2, Th3, Mor, Ot1, Ot2] and the asymptotic or large scale structure of the universal cover was very important for these results.

Our goal is to analyse what can a flow say about the asymptotic structure of the universal cover of the manifold. Here we consider pseudo-Anosov flows as they have rich dynamics and have been shown to be strongly connected to the geometry [Th3, Ot1] and topology of 3-manifolds [Ga-Oe, Fe6]. Gabai and Oertel proved for example that the universal cover of the underlying manifold is  $\mathbf{R}^3$  [Ga-Oe]. We will prove that under certain hypothesis the dynamics of the flow creates a much richer asymptotic structure for the universal cover.

---

\*Reseach partially supported by NSF grant DMS-0305313.

†Mathematics Subject Classification. Primary: 37D20, 53C23, 57R30, 37C85; Secondary: 57M50, 37D50, 58D19.

In this article all manifolds are connected.

We start by analysing the orbit space of the flow. Suppose that  $\Phi$  is a general pseudo-Anosov flow in a closed 3-manifold  $M$ . Such flows are very common [Th4, Bl-Ca, Mo2, Mo3, Th5, Fe6, Cal2, Cal3]. The flow has associated stable and unstable (possibly singular) 2-dimensional foliations  $\Lambda^s, \Lambda^u$ . When there are no singularities the flow is called an Anosov flow. Let  $\tilde{\Phi}$  be the lifted flow to the universal cover  $\tilde{M}$  and let  $\mathcal{O}$  be the orbit space of  $\tilde{\Phi}$ . This orbit space is always homeomorphic to an open disk [Fe1, Fe-Mo]. The fundamental group of  $M$  acting on  $\tilde{M}$  by covering translations, leaves invariant the foliation of  $\tilde{M}$  by flowlines of  $\tilde{\Phi}$ . Hence this induces an action of the fundamental group on  $\mathcal{O}$ . The stable and unstable foliations of  $\Phi$  lifted to the universal cover also induce one dimensional foliations in  $\mathcal{O}$ . We first analyse the asymptotic behavior of the orbit space:

**Theorem A** – Let  $\Phi$  be a pseudo-Anosov flow in a closed 3-manifold  $M$ . There is a natural construction of a compactification  $\mathcal{D} = \mathcal{O} \cup \partial\mathcal{O}$ , obtained solely from the stable and unstable foliations in  $\mathcal{O}$ . The boundary  $\partial\mathcal{O}$  is homeomorphic to a circle and the compactification  $\mathcal{D}$  is homeomorphic to a disk, whose boundary circle is  $\partial\mathcal{O}$ . Since the fundamental group of  $M$  preserves the stable and unstable foliations in  $\mathcal{O}$ , it follows that  $\pi_1(M)$  acts by homeomorphisms on the compactification  $\mathcal{D}$  and also along the boundary circle  $\partial\mathcal{O}$ .

We stress that compactifications of  $\mathcal{O}$  are not unique, even compactifications to a closed disk. For example given a point  $p$  in the above mentioned ideal boundary  $\partial\mathcal{O}$ , one can blow each point of the  $\pi_1(M)$  orbit of  $p$  to a segment. By doing this carefully the ensuing compactification of  $\mathcal{O}$  is again a closed disk where one can define a (non natural) action of  $\pi_1(M)$ .

The stable/unstable foliations  $\tilde{\Lambda}^s, \tilde{\Lambda}^u$  in the universal cover project to 1-dimensional foliations  $\mathcal{O}^s, \mathcal{O}^u$  in  $\mathcal{O}$ . The possible singularities are only of  $p$ -prong type with  $p \geq 3$  (the condition  $p \geq 3$  is necessary for all the results in this article). The prototype here is a suspension pseudo-Anosov flow over a hyperbolic surface. In this case  $\mathcal{O}$  is identified with a lift of a fiber and it is possible to prove that the ideal circle boundary of  $\mathcal{O}$  constructed in theorem A is identified with the circle at infinity of the lift of the fiber. In this example  $\mathcal{O}^s, \mathcal{O}^u$  in  $\mathcal{O}$  correspond to the stable and unstable foliations of the monodromy of the fiber lifted to the universal cover of the fiber. We stress that in general there is no geometry (even coarse geometry) in the space  $\mathcal{O}$ .

For general pseudo-Anosov flows, an ideal point of  $\mathcal{O}$  will be defined as an equivalence class of nested sequences of polygonal paths. A *polygonal path* is a properly embedded, bi-infinite path in  $\mathcal{O}$  made up of a finite collection of segments alternatively in  $\mathcal{O}^s, \mathcal{O}^u$  and 2 rays of  $\mathcal{O}^s$  or  $\mathcal{O}^u$  at the ends. In general one needs to use polygonal paths rather than just leaves of  $\mathcal{O}^s, \mathcal{O}^u$  to define ideal points of  $\mathcal{O}$  because of an obstruction which is called a perfect fit, as explained below. Any ray of a leaf of  $\mathcal{O}^s, \mathcal{O}^u$  is properly embedded in  $\mathcal{O}$  and defines an ideal point of  $\mathcal{O}$ , but there are many other points. There is a natural group invariant topology in  $\mathcal{D} = \mathcal{O} \cup \partial\mathcal{O}$  – this is a fundamental point here: the ideal points ( $\partial\mathcal{O}$ ) and the topology in  $\mathcal{D}$  are constructed using only the foliations  $\mathcal{O}^s, \mathcal{O}^u$  in  $\mathcal{O}$ . Since these foliations are invariant under the action by the fundamental group of  $M$ , then this group acts on  $\mathcal{D}$  by homeomorphisms. The proof that  $\mathcal{D}$  is homeomorphic to a closed disk is very involved and extremely long. We show that  $\partial\mathcal{O}$  has a natural cyclic order and that  $\partial\mathcal{O}$  is metrizable, connected and more importantly it is compact. The last property is very hard to prove. Point set topology theorems and additional work show that  $\partial\mathcal{O}$  is homeomorphic to a circle and  $\mathcal{D}$  is homeomorphic to a closed disk. This works for any pseudo-Anosov flow.

We remark that Calegari and Dunfield [Ca-Du] previously showed that if  $\Phi$  is a pseudo-Anosov flow, then  $\pi_1(M)$  acts nontrivially on a circle, with very important consequences for the existence question of pseudo-Anosov flows [Ca-Du]. Their construction is very different than ours. They show that the space of ends of the leaf space of say  $\tilde{\Lambda}^s$  is circularly ordered and maps injectively to a circle. By collapsing complementary intervals one gets an action on  $\mathbf{S}^1$ . It is not entirely clear how to use the space of ends in order to produce an actual compactification of  $\mathcal{O}$ , where the group acts naturally and with good properties. For example, consider sequences escaping compact sets in  $\mathcal{O}$  with all points in the same

stable leaf. As seen in the leaf space the points do not go into any end, but they should have a convergent subsequence in a compactification of  $\mathcal{O}$ . In this article we produce an actual compactification of the orbit space  $\mathcal{O}$  as a closed disk. In addition very specific properties of the compactification as related to the stable/unstable foliations  $(\mathcal{O}^s, \mathcal{O}^u)$  will be used for the geometric results in the second part of this article.

One main goal in introducing an ideal boundary for  $\mathcal{O}$  is that it leads to an understanding of the asymptotic behavior of  $\widetilde{M}$ . Our objective is to give a fairly explicit dynamical systems description of the asymptotic behavior of the universal cover. We do not know how to do this in general – in this article we can only deal with pseudo-Anosov flows without perfect fits.

We first discuss perfect fits and their importance. An unstable leaf  $G$  of  $\widetilde{\Lambda}^u$  makes a *perfect fit* with a stable leaf  $F$  of  $\widetilde{\Lambda}^s$  if  $G$  and  $F$  do not intersect but they “almost” intersect: any other unstable leaf sufficiently near  $G$  (and in the  $F$  side), will intersect  $F$  and vice versa. See detailed definition in section 2 (figure 1, a). We also use the terminology perfect fits for their projections to the orbit space. In the orbit space one can think of a perfect fit as a proper embedding in  $\mathcal{O}$  of a rectangle minus a corner. Stable (unstable) leaves correspond to horizontal (vertical) segments. The 2 boundary leaves without an endpoint form a perfect fit – one stable leaf (horizontal) and one unstable leaf (vertical). Perfect fits are very important in the topological theory of pseudo-Anosov flows, see [Ba1, Ba2, Fe1, Fe2, Fe4, Fe5]. They occur for instance whenever there are closed orbits of  $\Phi$  which are freely homotopic [Fe4, Fe5] or when the leaf space of  $\widetilde{\Lambda}^s$  or  $\widetilde{\Lambda}^u$  is not Hausdorff [Fe4, Fe5]. Examples of flows without perfect fits are suspensions (with or without singularities) and many other interesting examples as described later.

For the results in this article, perfect fits are one main obstruction to simple definitions and proofs: For example consider a point  $p$  of  $\partial\mathcal{O}$  which is associated to the ideal point of (say) an unstable ray  $l$  of  $\mathcal{O}^u$ . Let  $(z_n)_{n \in \mathbb{N}}$  be a nested sequence of stable leaves intersecting  $l$  and so that the intersection with  $l$  escapes compact sets in  $l$ . What one strongly expects and hopes is that the sequence  $(z_n)_{n \in \mathbb{N}}$  defines the ideal point  $p$  associated to  $l$ . In particular one expects that the leaves  $z_n$  escape compact sets in  $\mathcal{O}$  as  $n$  grows. This occurs in the suspension case and in many other situations, but in fact it does not always happen. When it does not occur, then the sequence  $(z_n)$  limits to a stable leaf  $r'$  in  $\mathcal{O}$  and one can then show that there is a stable leaf  $r$  (possibly  $r = r'$ ), so that  $r$  and  $l$  form a perfect fit in  $\mathcal{O}$ . In this case the sequence  $(z_n)$  will not define the ideal point  $p$ . Conversely any perfect fit generates a sequence  $(z_n)$  as above. Because of perfect fits then to define ideal points of  $\mathcal{O}$ , one needs to consider not only leaves of  $\mathcal{O}^s, \mathcal{O}^u$ , but rather sequences of polygonal paths in  $\mathcal{O}^s, \mathcal{O}^u$ . The definition of ideal points, implies that if  $r$  ray of  $\mathcal{O}^u$  and  $l$  ray of  $\mathcal{O}^s$  form a perfect fit, then these rays define the same ideal point of  $\mathcal{O}$ . Suspension Anosov flows (without singular orbits) are special and have to be treated differently, because in that case a sequence of stable leaves in  $\mathcal{O}^s$  escaping compact sets approaches infinitely many ideal points of  $\mathcal{O}$ .

When there are no perfect fits we construct the flow ideal boundary and compactification of  $\widetilde{M}$ . The flow ideal boundary is a quotient of  $\partial\mathcal{O}$ . The assumption of no perfect fits is fundamental for this result:

**Theorem B** – Let  $\Phi$  be a pseudo-Anosov flow without perfect fits and not topologically conjugate to a suspension Anosov flow. Let  $\mathcal{O}$  be its orbit space and  $\partial\mathcal{O}$  be the ideal boundary of theorem A. Consider the equivalence relation in  $\partial\mathcal{O}$  generated by: two points are in the same class if they are ideal points of the same stable or unstable leaf in  $\mathcal{O}$ . Let  $\mathcal{R}$  be the set of equivalence classes with the quotient topology. Then  $\mathcal{R}$  is homeomorphic to the 2-sphere. The fundamental group of  $M$  acts on  $\mathcal{R}$  by homeomorphisms. There is a natural topology in  $\widetilde{M} \cup \mathcal{R}$  making it into a compactification of  $\widetilde{M}$ . The action of  $\pi_1(M)$  on  $\widetilde{M}$  extends to an action on  $\widetilde{M} \cup \mathcal{R}$ . The quotient map from  $\partial\mathcal{O} (\cong \mathbf{S}^1)$  to  $\mathcal{R} (\cong \mathbf{S}^2)$  is a group invariant Peano curve associated to the flow  $\Phi$ . All of this uses only the dynamics of the flow  $\Phi$ .

If  $x$  in  $\partial\mathcal{O}$  is an ideal point of (say) a stable leaf in  $\mathcal{O}^s$ , then the condition of no perfect fits implies that no unstable leaf has ideal point  $x$ . Hence if  $k$  is the maximum number of prongs in singular leaves of  $\mathcal{O}^s$  (or  $\mathcal{O}^u$ ), then any equivalence class has at most  $k$  points.

Our goal is to relate the flow ideal compactification with well known objects in three manifold topology. We have actions of  $\pi_1(M)$  on a circle ( $\partial\mathcal{O}$ ) and a sphere ( $\mathcal{R}$ ). Motivated by a lot of previous work in 2

and 3-dimensional topology, one asks whether such actions are convergence group actions. For example a group that acts as a uniform convergence group on the circle is topologically conjugate to a Moebius group [Tu1, Ga2, Ca-Ju] with fundamental consequences for 3-manifold theory [Ga2, Ca-Ju]. Also a fundamental question of Cannon [Ca-Sw] asks whether a uniform convergence group acting on a 2-sphere is conjugate to a cocompact Kleinian group. This is related to the geometrization of 3-manifolds.

A compactum is a compact Hausdorff space. A group  $\Gamma$  acts as a *convergence group* on a metrisable compactum  $Z$  if for any sequence  $(\gamma_n)_{n \in \mathbb{N}}$  of distinct elements in  $\Gamma$ , there is a subsequence  $(\gamma_{n_i})_{i \in \mathbb{N}}$  and a source/sink pair  $y, x$  so that  $(\gamma_{n_i}(t))_{i \in \mathbb{N}}$  converges uniformly to the constant map with value  $x$  in compact sets of  $Z - \{y\}$  [Ge-Ma]. Notice that  $x, y$  may be the same point. This is equivalent to  $\Gamma$  acting properly discontinuously on the set of distinct triples  $\Theta_3(Z)$  of elements of  $Z$  [Tu2, Bo2]. In addition the action is *uniform* if the quotient of  $\Theta_3(Z)$  by the action is compact. If  $Z$  is perfect (no isolated points) then the additional condition is equivalent to every point of  $Z$  being a conical limit point for the action. A point  $x$  in  $Z$  is a *conical limit point* if there is a sequence  $(\gamma_n)_{n \in \mathbb{N}}$  in  $\Gamma$  and  $b, c$  distinct in  $Z$ , with  $\gamma_n(x)$  converging to  $c$  but for every other point  $y$  in  $Z$  then  $(\gamma_n(y))$  converges to  $b$ .

The action of  $\pi_1(M)$  on  $\partial\mathcal{O}$  is not a convergence action. Here is the proof: let  $g$  non trivial in  $\pi_1(M)$  so that  $g$  fixes a point  $x$  in  $\mathcal{O}$ . Equivalently  $g$  is associated to a periodic orbit of  $\Phi$ . Up to taking a power assume that  $g$  leaves invariant all prongs of  $\mathcal{O}^s(x), \mathcal{O}^u(x)$ . Hence it fixes the points in  $\partial\mathcal{O}$  which are the ideal points of these prongs. We show in this article that all these ideal points are distinct points of the circle. In addition the fixed points alternate between contracting and expanding fixed points for  $g$ . Now consider the sequence  $(g^n)$  acting on  $\partial\mathcal{O}$ . The above facts imply that all elements in this sequence of distinct elements of  $\pi_1(M)$  (or any subsequence) will share more than 2 fixed points and hence the sequence  $(g^n)$  does not have a single source/sink pair. Hence the action of  $\pi_1(M)$  on  $\partial\mathcal{O}$  is not a convergence group action.

**Main theorem** – Let  $\Phi$  be a pseudo-Anosov flow without perfect fits and not topologically conjugate to a suspension Anosov flow. Let  $\mathcal{R}$  be the associated flow ideal boundary with corresponding compactification  $\widetilde{M} \cup \mathcal{R}$  of the universal cover. Then the action of  $\pi_1(M)$  on  $\mathcal{R}$  is a uniform convergence group. In addition the action of  $\pi_1(M)$  on  $\widetilde{M} \cup \mathcal{R}$  is a convergence group.

The main part of the proof is to prove uniform convergence action on  $\mathcal{R}$ . Here 1-dimensional dynamics (action on the circle  $\partial\mathcal{O}$ ) completely encodes the 2-dimensional dynamics (action on  $\mathcal{R}$ ). A lot of the proof can be done using only this interplay and the action on the 2-dimensional space  $\mathcal{O}$ , but as expected the 3-dimensional setting of the flow  $\Phi$  in the universal cover of  $M$  needs to be used in some crucial steps.

To prove the convergence group property, we break into three cases up to subsequences: 1) every  $\gamma_n$  is associated to a singular orbit of  $\Phi$ , 2) every  $\gamma_n$  is associated to a nonsingular closed orbit of  $\Phi$ , 3) every  $\gamma_n$  acts freely on  $\mathcal{O}$ . For example consider case 2). Up to taking squares, the action of  $\gamma_n$  in  $\partial\mathcal{O}$  immediately has 4 fixed points, associated to the two ideal points of the stable leaf of the periodic orbit and the two unstable ones. By dynamics of pseudo-Anosov flows, the stable points are locally attracting for the action of  $\gamma_n$  on  $\partial\mathcal{O}$  and the unstable ones are locally repelling. When there are no perfect fits, this carries over to the whole of  $\partial\mathcal{O}$ . As the 2 ideal points of a stable leaf are identified in  $\mathcal{R}$ , this produces a source/sink behavior for (powers of) one  $\gamma_n$ . An extended analysis shows the source/sink behavior for sequences. The uniform property of the action is achieved by showing that every point of  $\mathcal{R}$  is a conical limit point. The proofs of these results are very involved.

To prove the fact about the action on  $\widetilde{M} \cup \mathcal{R}$ , consider a sequence of distinct elements  $(\gamma_n)_{n \in \mathbb{N}}$  of  $\pi_1(M)$ . At this point we will already know that up to subsequence it has a source/sink pair  $y, x$  for the action restricted to  $\mathcal{R}$ . We then show that  $y, x$  is a source sink pair for the action on  $\widetilde{M} \cup \mathcal{R}$ . This depends on a careful analysis of neighborhoods in  $\widetilde{M} \cup \mathcal{R}$  of points in  $\mathcal{R}$ . The harder case is when such a point comes from an ideal point of a leaf of  $\mathcal{O}^s$  or  $\mathcal{O}^u$ . The main theorem implies in particular that the action of  $\pi_1(M)$  on  $\mathcal{R}$  (or on  $\partial\mathcal{O}$ ) is minimal.

We mention that when there are perfect fits it is not at all clear what is the resulting structure of the quotient space  $\mathcal{R}$ . For example consider  $\Phi$  an  $\mathbf{R}$ -covered Anosov flow, see [Fe1]. There are infinitely

many examples where  $M$  is hyperbolic [Fe1]. In this case the quotient  $\mathcal{R}$  (of the circle  $\partial\mathcal{O}$ ) as defined in theorem B, is a union of a circle and two special points: each special point is non separated from every point in the circle [Fe1, Th5]. Hence  $\mathcal{R}$  is not even metrizable. Clearly in this case the quotient  $\mathcal{R}$  does not provide the expected ideal boundary of  $\widetilde{M}$  (which is a sphere).

This finishes the topological/dynamical systems part of the article. In the remainder of the article we use the excellent properties of  $\mathcal{R}$  and  $\widetilde{M} \cup \mathcal{R}$  to relate them with the large scale geometry of the manifold. This has geometric consequences for the fundamental group of the manifold and also for flows and foliations. In particular we give an entirely new proof that the fundamental group of closed, atoroidal 3-manifolds that fiber over the circle is Gromov hyperbolic.

The key tool will be the following: Bowditch [Bo1], following ideas of Gromov, proved the very interesting theorem that if  $\Gamma$  acts as a uniform convergence group on a perfect, metrisable compactum  $Z$ , then  $\Gamma$  is Gromov hyperbolic,  $Z$  is homeomorphic to the Gromov ideal boundary  $\partial\Gamma$  and the action on  $Z$  is equivariantly topologically conjugate to the action of  $\Gamma$  on its Gromov ideal boundary. This is a true geometrization theorem (in the sense of groups): the hypothesis are entirely topological on the group action and there is a strong geometric conclusion. The main theorem then immediately implies the following:

**Theorem D** – Let  $\Phi$  be a pseudo-Anosov flow without perfect fits and not topologically conjugate to a suspension Anosov flow. Let  $\mathcal{R}$  be the associated flow ideal boundary of  $\widetilde{M}$  and  $\widetilde{M} \cup \mathcal{R}$  the flow ideal compactification. Then  $\pi_1(M)$  is Gromov hyperbolic and the action of  $\pi_1(M)$  on  $\mathcal{R}$  is topologically conjugate to the action on the Gromov ideal boundary  $S_\infty^2$ . In addition the actions on  $\widetilde{M} \cup \mathcal{R}$  and  $\widetilde{M} \cup S_\infty^2$  are also topologically conjugate – by a homomorphism which is the identity in  $\widetilde{M}$ .

It was known that the Gromov boundary of  $\pi_1(M)$  is a sphere because  $M$  is irreducible [Be-Me]. To prove the last statement of theorem D: Let  $\xi$  be the bijection between  $\widetilde{M} \cup \mathcal{R}$  and  $\widetilde{M} \cup S_\infty^2$ , which is the identity in  $\widetilde{M}$  and the conjugacy of the actions in  $\mathcal{R}$ . Clearly this is group equivariant. We show that the bijection  $\xi$  is continuous. This follows from the convergence group action properties for the action on  $\widetilde{M} \cup \mathcal{R}$  plus the conjugacy between the actions on  $\mathcal{R}$  and  $S_\infty^2$ . Theorem D means that the constructions of this article can be seen as a dynamical systems analogue to Gromov’s geometric constructions in the case of this class of pseudo-Anosov flows.

A few remarks are in order here. In theorem D, the result that  $\pi_1(M)$  is Gromov hyperbolic is not new and also follows from a result of Gabai-Kazez [Ga-Ka] and additional work. The reason is: if  $M$  with a pseudo-Anosov flow is toroidal, then either there is a free homotopy between closed orbits of the flow or the flow is topologically conjugate to a suspension Anosov flow [Fe7]. The last option is disallowed by hypothesis of theorem D. If there is a free homotopy between closed orbits then there are perfect fits [Fe4, Fe5]. Hence the hypothesis of theorem D imply that  $M$  is atoroidal. With further analysis using the topological theory of pseudo-Anosov flows [Fe4, Fe5] one can then show that  $\Phi$  has singular orbits. Therefore the (singular) stable foliation blows up to an essential lamination which is genuine, so [Ga-Ka] implies that  $\pi_1(M)$  is Gromov hyperbolic. Gabai and Kazez showed that least area disks in  $M$  satisfy a linear isoperimetric inequality. The proof of this last fact uses the ubiquity theorem for semi-Euclidean laminations of Gabai [Ga3]. This is a deep but very mysterious result. In particular it provides no direct relationship with the Gromov ideal boundary.

The important new feature of theorem D is that it relates the flow structure with the large scale geometric structure. Our construction gives a very explicit description of the Gromov ideal boundary of  $\widetilde{M}$  – first as a purely dynamical systems object and a posteriori implying that  $\pi_1(M)$  is Gromov hyperbolic and totally relating the two ideal boundaries. In particular this is a new approach to obtain Gromov hyperbolicity. There are several important geometric consequences. First we obtain a new proof of a classical result:

**Corollary E** – Let  $\Phi$  be a suspension pseudo-Anosov flow with at least a singular orbit in a closed 3-manifold  $M$ . Then  $\pi_1(M)$  is Gromov hyperbolic.

This theorem has two well known proofs: the original by Thurston [Th3] and a later proof by Bestvina and Feighn [Be-Fe]. Thurston's original proof uses quasiconformal maps, Kleinian groups and the double limit theorem and obviously proves much more – it proves that  $M$  admits a hyperbolic metric. Bestvina and Feighn's proof is a geometric group theory proof and introduces the extremely useful condition of flaring annuli. Our proof is entirely new in the sense that it uses dynamical systems and convergence groups via Bowditch's theorem.

The proof of corollary E is as follows: Let  $S$  be a cross section of  $\Phi$ . Since there is a singularity of  $\Phi$ ,  $S$  is a hyperbolic surface. We already mentioned that the orbit space of  $\Phi$  is identified with the universal cover  $\tilde{S}$  and the foliations  $\mathcal{O}^s, \mathcal{O}^u$  in  $\mathcal{O}$  are identified with lifts  $\tilde{f}^s, \tilde{f}^u$  of the stable and unstable foliations of the monodromy of the fibration. According to corollary D all that is needed is to prove that there are no perfect fits. Notice that this is a topological condition. We will check this for  $\tilde{f}^s, \tilde{f}^u$ . Consider  $S$  with a hyperbolic metric, hence  $\tilde{S}$  is the hyperbolic plane. If there is a perfect fit between  $\tilde{f}^s$  and  $\tilde{f}^u$ , then there is a ray  $l$  of (say)  $\tilde{f}^s$  so that: if  $s_n$  is a sequence of unstable leaves (of  $\tilde{f}^u$ ) intersecting  $l$  and with  $l \cap s_n$  escaping to the appropriate end of  $l$  then  $s_n$  does not escape compact sets in  $\tilde{S}$  and converges to a leaf  $s$  of  $\tilde{f}^u$ . Now use the fundamental property that leaves of  $\tilde{f}^s, \tilde{f}^u$  are uniform quasigeodesics in  $\tilde{S}$  [Th4, FLP]. It follows that  $s$  is unique and that  $l, s$  have a common ideal point in  $\partial\tilde{S}$ . This is impossible [Th4, FLP]. This finishes the proof of corollary E. As a remark for future reference, the case of pseudo-Anosov flows without perfect fits shares many features with the suspension pseudo-Anosov situation: the property alluded above about ideal points of  $l$  and  $s$  has an analogue for general pseudo-Anosov flows without perfect fits. This is the content of the escape lemma (lemma 4.4). The escape lemma is extremely useful for the analysis of pseudo-Anosov flows without perfect fits.

We should remark that if  $M$  is closed, irreducible, aspherical, atoroidal and with infinite fundamental group then Perelman's results [Pe1, Pe2, Pe3] show that  $M$  is hyperbolic. We do not make use of Perelman's results here. We stress again that a fundamental goal of this article is to analyse which geometric information can be obtained solely from dynamical systems constructions.

We now describe other very important geometric consequences of theorem D. Flow objects (flowlines, stable/unstable leaves, foliations transverse to the flow) behave very well in the compactification  $\tilde{M} \cup \mathcal{R}$ . Since this is homeomorphic to the Gromov compactification, it is natural to expect that these objects also have good geometric properties. First we study metric properties of such flows and their stable/unstable foliations. In manifolds with Gromov hyperbolic fundamental group the relation between objects in  $\tilde{M}$  and their limit sets is extremely important [Th1, Th2, Th3, Gr, Gh-Ha, CDP] and is related to the large scale geometry in  $\tilde{M}$ . A flow in  $M$  is *quasigeodesic* if flow lines in  $\tilde{M}$  are uniformly efficient in measuring ambient distance up to a bounded multiplicative distortion [Th1, Gr, Gh-Ha, CDP]. It implies that each flow line is a bounded distance from the corresponding geodesic which has the same ideal points. Quasigeodesic flows are very useful [Ca-Th, Mo1, Mo2, Fe2]. Usually it is very hard to show that a flow is quasigeodesic and there is no general construction of quasigeodesic flows in hyperbolic manifolds – the known class of examples is relatively small. Theorem D provides a powerful way to obtain quasigeodesic flows:

**Theorem F** – Let  $\Phi$  be a pseudo-Anosov flow without perfect fits. Then  $\Phi$  is a quasigeodesic flow in  $M$ . In addition  $\Lambda^s, \Lambda^u$  are quasi-isometric singular foliations in  $M$ .

First assume that  $\Phi$  is not topologically conjugate to a suspension Anosov flow. By theorem D,  $\pi_1(M)$  is Gromov hyperbolic. To prove theorem F we first prove some properties in the flow compactification  $\tilde{M} \cup \mathcal{R}$ : 1) Each flow line  $\gamma$  of  $\tilde{\Phi}$  has a unique forward ideal point  $\gamma_+$  in  $\mathcal{R}$  and a backward ideal point  $\gamma_-$ ; 2) For each  $\gamma$  the points  $\gamma_-, \gamma_+$  are distinct; 3) The forward (backward) ideal point map is continuous. Theorem D conjugates the action in  $\tilde{M} \cup \mathcal{R}$  to the action in  $\tilde{M} \cup S_\infty^2$ , hence the same properties are true in  $\tilde{M} \cup S_\infty^2$ . A previous result of the author and Mosher [Fe-Mo] then implies that  $\Phi$  is quasigeodesic.

*Quasi-isometric* behavior for  $\Lambda^s, \Lambda^u$  means that leaves of  $\Lambda^s$  (or  $\Lambda^u$ ) are uniformly efficient in measuring distance in  $\tilde{M}$  [Th1, Gr, CDP]. This is the analogue of quasigeodesic behavior in the two dimensional

setting and again it is extremely useful [Gr, Th1, Th2, Th3]. For example it implies that leaves of  $\tilde{\Lambda}^s, \tilde{\Lambda}^u$  are quasiconvex [Th1, Gr]. Quasi-isometric foliations are very useful [Ca-Th, Th5, Fe5, Fe8]. To prove the second part of theorem F: the lack of perfect fits implies that the leaf spaces of  $\tilde{\Lambda}^s, \tilde{\Lambda}^u$  are Hausdorff [Fe4, Fe5]. Together with the fact that  $\Phi$  is quasigeodesic this now implies that  $\Lambda^s, \Lambda^u$  are quasi-isometric foliations [Fe5]. This provides a new way to obtain quasi-isometric singular foliations in such manifolds.

If now  $\Phi$  is topologically conjugate to a suspension Anosov flow, then quasigeodesic behavior of  $\Phi$  and quasi-isometric behavior of  $\Lambda^s, \Lambda^u$  are easy to prove.

Finally we apply these results to (nonsingular) foliations and their asymptotic properties and we show that pseudo-Anosov flows without perfect fits are very common. A foliation  $\mathcal{F}$  in a 3-manifold is  $\mathbf{R}$ -covered if the leaf space  $\mathcal{H}$  of  $\tilde{\mathcal{F}}$  is Hausdorff or equivalently homeomorphic to the real numbers.  $\mathbf{R}$ -covered foliations are very common [He, Fe1, Th5, Cal1]. On the other hand if  $\mathcal{H}$  is not Hausdorff then it is a simply connected, non Hausdorff, 1-dimensional manifold with a countable basis [Ba3]. Hence it is orientable. The non separated points in  $\mathcal{H}$  correspond to branching in the negative (positive) direction if they are separated on their positive (negative) sides. A foliation  $\mathcal{F}$  has one sided branching if the branching in  $\tilde{\mathcal{F}}$  is only in one direction (positive or negative).

If  $\mathcal{F}$  is a Reebless foliation in  $M^3$  aspherical with  $\pi_1(M)$  Gromov hyperbolic then each leaf  $F$  of  $\tilde{\mathcal{F}}$  is uniformly Gromov hyperbolic in its path metric and has an ideal circle  $\partial_\infty F$  compactifying it to a closed disk  $F \cup \partial_\infty F$ . The *continuous extension question* asks what is the asymptotic behavior of the leaves of  $\tilde{\mathcal{F}}$ , that is, do they approach the ideal boundary  $S_\infty^2$  in a continuous way? This is formulated as follows: Does the inclusion  $i : F \rightarrow \tilde{M}$  extend continuously to  $i : F \cup \partial_\infty F \rightarrow \tilde{M} \cup S_\infty^2$ ? If so then  $i$  restricted to  $\partial_\infty F$  is a continuous parametrization of the limit set of  $F$ , which will be locally connected. When this happens for all leaves of  $\tilde{\mathcal{F}}$ , we say that  $\mathcal{F}$  has the continuous extension property [Gal, Ca-Th, Fe5]. This property is very hard to prove.

We use the geometric tools developed in this article to prove the following theorem. For any codimension one foliation  $\mathcal{F}$  if it is not transversely orientable there is a transversely orientable lift  $\mathcal{F}_2$  in a double cover  $M_2$  of  $M$ . If  $\mathcal{F}$  is transversely orientable we abuse notation and let  $M_2 = M$  and  $\mathcal{F}_2 = \mathcal{F}$ . If  $M$  is aspherical and atoroidal then the author [Fe6] and Calegari [Cal2] proved that there is a pseudo-Anosov flow  $\Phi$  which is transverse to  $\mathcal{F}_2$  in  $M_2$ .

**Theorem G** – Let  $\mathcal{F}$  be an  $\mathbf{R}$ -covered foliation in an aspherical, atoroidal 3-manifold  $M$ . The pseudo-Anosov flow  $\Phi$  transverse to the transversely oriented foliation  $\mathcal{F}_2$  associated to  $\mathcal{F}$  does not have perfect fits and is not conjugate to a suspension Anosov flow. It follows that  $\Phi$  is quasigeodesic by Theorem F and this in turn implies that  $\mathcal{F}_2$  satisfies the continuous extension property. This trivially implies that  $\mathcal{F}$  satisfies the continuous extension property. In addition the stable/unstable foliations of  $\Phi$  (in the cover  $M_2$ ) are quasi-isometric.

The aspherical property is used only to get rid of a manifold which is finitely covered by  $\mathbf{S}^2 \times \mathbf{S}^1$ . The problem is that the  $\mathbf{R}$ -covered property does not imply that the foliation is Reebless. For example consider the foliation  $\mathcal{F}$  of  $\mathbf{S}^2 \times \mathbf{S}^1$  which is obtained by glueing two Reeb components appropriately. If one is careful, then  $\mathcal{F}$  is  $\mathbf{R}$ -covered. On the other hand the author previously proved that if  $\mathcal{F}$  is  $\mathbf{R}$ -covered, but not Reebless, then  $M$  is finitely covered by  $\mathbf{S}^2 \times \mathbf{S}^1$  [Fe8]. Apart from this special case, the universal cover is homeomorphic to  $\mathbf{R}^3$  and the results of the author and Calegari can be applied.

The continuous extension property was previously proved for: 1) fibrations in the seminal work of Cannon and Thurston [Ca-Th], 2) Finite depth foliations and some other classes by the author [Fe5, Fe8], 3) slitherings or uniform foliations by Thurston [Th5]. The methods of the proof were very different from those in this article – in all of the previous cases one always had a strong geometric property to start with: For example in the case of finite depth foliations (not fibrations), the compact leaf is quasi-isometrically embedded and therefore quasiconvex. After some work this implies that the almost transverse pseudo-Anosov flow is quasigeodesic. After substantial more work this implies the continuous extension property for the foliation. The problem in general is that for instance in an arbitrary  $\mathbf{R}$ -covered foliation, the

leaves have no good geometric property to start with – so these methods do not work. In this article we obtain geometric properties for the flow directly and solely from the dynamics of the pseudo-Anosov flow and this can then be applied to the foliations. Theorem G implies the previous results for fibrations and slitherings. Theorem G produces new examples of quasigeodesic flows and quasi-isometric foliations.

In order to prove theorem G assume that  $\mathcal{F}$  is transversely oriented and start with a pseudo-Anosov flow  $\Phi$  transverse to  $\mathcal{F}$  as constructed in [Fe6] or [Cal2]. We show that  $\Phi$  is not conjugate to a suspension Anosov flow and has no perfect fits. By theorem F, the flow  $\Phi$  is quasigeodesic and its stable/unstable foliations are quasi-isometric. By previous results [Fe8], it follows that  $\mathcal{F}$  has the continuous extension property.

We also consider foliations with one sided branching and prove:

**Theorem H** – Let  $\mathcal{F}$  be a foliation with one sided branching in  $M^3$  aspherical, atoroidal. Then  $\mathcal{F}$  is transverse to a pseudo-Anosov flow  $\Phi$  without perfect fits and not conjugate to a suspension Anosov flow. It follows that  $\Phi$  is quasigeodesic, its stable/unstable foliations are quasi-isometric and  $\mathcal{F}$  has the continuous extension property. If  $F$  is a leaf of  $\mathcal{F}$ , then the limit set of  $F$  is not the whole sphere.

Under the conditions of this theorem, Calegari [Cal3] proved that  $\mathcal{F}$  is transverse to a pseudo-Anosov flow  $\Phi$ . We show that such  $\Phi$  does not have perfect fits nor is conjugate to a suspension Anosov flow. By theorem F, the flow  $\Phi$  is quasigeodesic. This implies that  $\mathcal{F}$  has the continuous extension property. The last statement follows from metric properties of leaves of  $\tilde{\Lambda}^s, \tilde{\Lambda}^u$ .

The geometric applications obtained here (theorems E, F, G and H) were the main motivation for the construction of the flow ideal boundary of  $\tilde{M}$  and the ideal circle of  $\mathcal{O}$ .

The open case for the continuous extension question is contained in the case when  $\mathcal{F}$  branches in both directions. The case of finite depth foliations was resolved very recently in [Fe8] using work of Mosher, Gabai and the author [Mo3, Fe-Mo]. For general foliations with two sided branching, Calegari [Cal4] constructed a very full lamination transverse to  $\mathcal{F}$ , like the stable/unstable foliation of a flow. It is possible that in certain situations there are 2 laminations, which perhaps are transverse to each other and these can be possibly blown down to produce a pseudo-Anosov flow transverse or almost transverse to  $\mathcal{F}$  [Mo3]. When the ideal dynamics of the case of a pseudo-Anosov flow with perfect fits is better understood, then Calegari's results could be very useful.

The geometric properties of flows and foliations (theorems F, G and H) are proved at the end of the article, in sections 6 and 7. The proofs use the main theorem, theorem D and previous results. Theorems G, H provide a large class of examples of pseudo-Anosov flows without perfect fits and also quasigeodesic flows and quasi-isometric foliations. The bulk of the article is proving theorem A (section 3), theorem B and the main theorem (section 4). Gromov hyperbolicity and conjugacy are proved in section 5.

**How to read this article** – The body of the article has two main parts: 1) Section 3 – ideal boundary of  $\mathcal{O}$ , 2) Section 4 – flow ideal boundary for flows without perfect fits and uniform convergence group action. For those mainly interested in the geometric results (sections 4-7) we highlight in section 3 where the case without perfect fits has simplified proofs.

We thank Lee Mosher who told us about Bowditch's theorem. We also thank the reviewer who did an outstanding job of very carefully checking the whole article and who had innumerable useful comments, many detailed suggestions and corrections which were incorporated in this article.

## 2 Preliminaries: Pseudo-Anosov flows

Given  $M$  let  $\tilde{M} \rightarrow M$  be a fixed universal cover.

Let  $\Phi$  be a flow on a closed 3-manifold  $M$ . We say that  $\Phi$  is a *pseudo-Anosov flow* if the following are satisfied:

- For each  $x \in M$ , the flow line  $t \rightarrow \Phi(x, t)$  is  $C^1$ , it is not a single point, and the tangent vector bundle  $D_t\Phi$  is  $C^0$ .



- There is a finite number of periodic orbits  $\{\gamma_i\}$ , called *singular orbits*, such that the flow is “topologically” smooth off of the singular orbits (see below).

- The flowlines of  $\Phi$  are contained in two possibly singular 2-dimensional foliations  $\Lambda^s, \Lambda^u$  satisfying: Outside of the singular orbits, the foliations  $\Lambda^s, \Lambda^u$  are not singular, they are transverse to each other and their leaves intersect exactly along the orbits of  $\Phi$ . A leaf containing a singularity is homeomorphic to  $P \times I/f$  where  $P$  is a  $p$ -prong in the plane and  $f$  is a homeomorphism from  $P \times \{1\}$  to  $P \times \{0\}$ . We restrict to  $p$  at least 2, that is, we do not allow 1-prongs.

- In a stable leaf all orbits are forward asymptotic, in an unstable leaf all orbits are backwards asymptotic.

Basic references for pseudo-Anosov flows are [Mo1, Mo3].

The singular foliations lifted to  $\widetilde{M}$  are denoted by  $\widetilde{\Lambda}^s, \widetilde{\Lambda}^u$ . If  $x$  is a point in  $\widetilde{M}$  let  $W^s(x)$  denote the leaf of  $\Lambda^s$  containing  $x$ . Similarly one defines  $W^u(x)$  and in the universal cover  $\widetilde{W}^s(x), \widetilde{W}^u(x)$ . If  $\alpha$  is an orbit of  $\Phi$ , similarly define  $W^s(\alpha), W^u(\alpha)$ , etc... Let also  $\widetilde{\Phi}$  be the lifted flow to  $\widetilde{M}$ .

We review the results about the topology of  $\widetilde{\Lambda}^s, \widetilde{\Lambda}^u$  that we will need. We refer to [Fe4, Fe5] for detailed definitions, explanations and proofs. Proposition 4.2 of [Fe-Mo] shows that the orbit space of  $\widetilde{\Phi}$  in  $\widetilde{M}$  is homeomorphic to the plane  $\mathbf{R}^2$ . This orbit space is denoted by  $\mathcal{O} \cong \widetilde{M}/\widetilde{\Phi}$ . Let  $\Theta : \widetilde{M} \rightarrow \mathcal{O} \cong \mathbf{R}^2$  be the projection map. If  $L$  is a leaf of  $\widetilde{\Lambda}^s$  or  $\widetilde{\Lambda}^u$ , then  $\Theta(L) \subset \mathcal{O}$  is a tree which is either homeomorphic to  $\mathbf{R}$  if  $L$  is regular, or is a union of  $k$  rays all with the same starting point if  $L$  has a singular  $k$ -prong orbit. The foliations  $\widetilde{\Lambda}^s, \widetilde{\Lambda}^u$  induce singular 1-dimensional foliations  $\mathcal{O}^s, \mathcal{O}^u$  in  $\mathcal{O}$ . Its leaves are the  $\Theta(L)$ 's as above. If  $L$  is a leaf of  $\widetilde{\Lambda}^s$  or  $\widetilde{\Lambda}^u$ , then a *sector* is a component of  $\widetilde{M} - L$ . Similarly for  $\mathcal{O}^s, \mathcal{O}^u$ . If  $B$  is any subset of  $\mathcal{O}$ , we denote by  $B \times \mathbf{R}$  the set  $\Theta^{-1}(B)$ . The same notation  $B \times \mathbf{R}$  will be used for any subset  $B$  of  $\widetilde{M}$ : it will just be the union of all flow lines through points of  $B$ . If  $x$  is a point of  $\mathcal{O}$ , then  $\mathcal{O}^s(x)$  (resp.  $\mathcal{O}^u(x)$ ) is the leaf of  $\mathcal{O}^s$  (resp.  $\mathcal{O}^u$ ) containing  $x$ .

**Definition 2.1.** *Let  $L$  be a leaf of  $\widetilde{\Lambda}^s$  or  $\widetilde{\Lambda}^u$ . A slice leaf of  $L$  is  $l \times \mathbf{R}$  where  $l$  is a properly embedded copy of the real line in  $\Theta(L)$ . For instance if  $L$  is regular then  $L$  is its only slice leaf. If a slice leaf is the boundary of a sector of  $L$  then it is called a line leaf of  $L$ . If  $a$  is a ray in  $\Theta(L)$  then  $A = a \times \mathbf{R}$  is called a half leaf of  $L$ . If  $\zeta$  is an open segment in  $\Theta(L)$  it defines a flow band  $L_1$  of  $L$  by  $L_1 = \zeta \times \mathbf{R}$ .*

**Important convention** – In general a slice leaf is just a slice leaf of some  $L$  in  $\widetilde{\Lambda}^s$  or  $\widetilde{\Lambda}^u$  and so on. We also use the terms slice leaves, line leaves, perfect fits, lozenges and rectangles for the projections of these objects in  $\widetilde{M}$  to the orbit space  $\mathcal{O}$ .

If  $F \in \widetilde{\Lambda}^s$  and  $G \in \widetilde{\Lambda}^u$  then  $F$  and  $G$  intersect in at most one orbit. Also suppose that a leaf  $F \in \widetilde{\Lambda}^s$  intersects two leaves  $G, H \in \widetilde{\Lambda}^u$  and so does  $L \in \widetilde{\Lambda}^s$ . Then  $F, L, G, H$  form a *rectangle* in  $\widetilde{M}$  and there is no singularity of  $\widetilde{\Phi}$  in the interior of the rectangle see [Fe4] pages 637-638. There will be two generalizations of rectangles: 1) perfect fits = in the orbit space this is a properly embedded rectangle with one corner removed and 2) lozenges = rectangle with two opposite corners removed.

**Definition 2.2.** ([Fe2, Fe4]) *Perfect fits* - Two leaves  $F \in \widetilde{\Lambda}^s$  and  $G \in \widetilde{\Lambda}^u$ , form a perfect fit if  $F \cap G = \emptyset$  and there are half leaves  $F_1$  of  $F$  and  $G_1$  of  $G$  and also flow bands  $L_1 \subset L \in \widetilde{\Lambda}^s$  and  $H_1 \subset H \in \widetilde{\Lambda}^u$ , so that the set

$$\overline{F_1} \cup \overline{H_1} \cup \overline{L_1} \cup \overline{G_1}$$

separates  $M$  and the joint structure of  $\widetilde{\Lambda}^s, \widetilde{\Lambda}^u$  in a complementary component  $R$  is that of a rectangle as above without one corner orbit. Specifically, a stable leaf intersects  $H_1$  if and only if it intersects  $G_1$  and similarly for unstable leaves intersecting  $F_1, L_1$ .

We refer to fig. 1, a for perfect fits. We also say that the leaves  $F, G$  almost intersect.

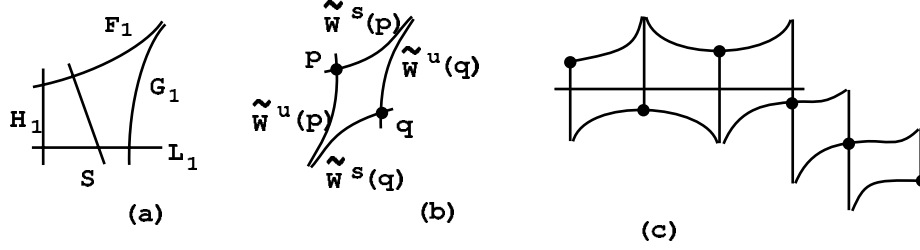

Figure 1: a. Perfect fits in  $\widetilde{M}$ , b. A lozenge, c. A chain of lozenges.

**Definition 2.3.** ([Fe2, Fe4]) *Lozenges* - A lozenge is an open region of  $\widetilde{M}$  whose closure in  $\widetilde{M}$  is homeomorphic to a rectangle with two corners removed. More specifically two orbits  $\alpha = \widetilde{\Phi}_{\mathbf{R}}(p), \beta = \widetilde{\Phi}_{\mathbf{R}}(q)$  form the corners of a lozenge if there are half leaves  $A, B$  of  $\widetilde{W}^s(\alpha), \widetilde{W}^u(\alpha)$  defined by  $\alpha$  and  $C, D$  half leaves of  $\widetilde{W}^s(\beta), \widetilde{W}^u(\beta)$  so that  $A$  and  $D$  form a perfect fit and so do  $B$  and  $C$ . The region in  $\widetilde{M}$  bounded by  $A, B, C, D$  is the lozenge  $R$  and it does not have any singularities. See fig. 1, b.

This is definition 4.4 of [Fe5]. The sets  $A, B, C, D$  are the sides of the lozenge. There may be singular orbits on the sides of the lozenge and the corner orbits. Two lozenges are *adjacent* if they share a corner and there is a stable or unstable leaf intersecting both of the lozenges, see fig. 1, c. Therefore they share a side. A *chain of lozenges* is a collection  $\{\mathcal{C}_i\}, i \in I$ , of lozenges where  $I$  is an interval (finite or not) in  $\mathbf{Z}$ , so that if  $i, i+1 \in I$ , then  $\mathcal{C}_i$  and  $\mathcal{C}_{i+1}$  share a corner, see fig. 1, c. Consecutive lozenges may be adjacent or not. The chain is finite if  $I$  is finite.

**Definition 2.4.** Suppose  $A$  is a flow band in a leaf of  $\widetilde{\Lambda}^s$ . Suppose that for each orbit  $\gamma$  of  $\widetilde{\Phi}$  in  $A$  there is a half leaf  $B_\gamma$  of  $\widetilde{W}^u(\gamma)$  defined by  $\gamma$  so that: for any two orbits  $\gamma, \beta$  in  $A$  then a stable leaf intersects  $B_\beta$  if and only if it intersects  $B_\gamma$ . This defines a stable product region which is the union of the  $B_\gamma$ . Similarly define unstable product regions.

The main property of product regions is the following, see [Fe5] page 641: for any  $F \in \widetilde{\Lambda}^s, G \in \widetilde{\Lambda}^u$  so that (i)  $F \cap A \neq \emptyset$  and (ii)  $G \cap A \neq \emptyset$ , then  $F \cap G \neq \emptyset$ . There are no singular orbits of  $\widetilde{\Phi}$  in  $A$ .

We abuse convention and say that a leaf  $L$  of  $\widetilde{\Lambda}^s$  or  $\widetilde{\Lambda}^u$  is *periodic* if there is a non trivial covering translation  $g$  of  $\widetilde{M}$  with  $g(L) = L$ . This is equivalent to  $\pi(L)$  containing a periodic orbit of  $\Phi$ , which may or may not be singular. In the same way, an orbit  $\gamma$  of  $\widetilde{\Phi}$  is *periodic* if  $\pi(\gamma)$  is a periodic orbit of  $\Phi$ . Finally a leaf  $l$  of  $\mathcal{O}^s$  or  $\mathcal{O}^u$  is periodic if there is  $g \neq \text{id}$  in  $\pi_1(M)$  with  $g(l) = l$ .

We say that two orbits  $\gamma, \alpha$  of  $\widetilde{\Phi}$  (or the leaves  $\widetilde{W}^s(\gamma), \widetilde{W}^s(\alpha)$ ) are connected by a chain of lozenges  $\{\mathcal{C}_i\}, 1 \leq i \leq n$ , if  $\gamma$  is a corner of  $\mathcal{C}_1$  and  $\alpha$  is a corner of  $\mathcal{C}_n$ . If a lozenge  $\mathcal{C}$  has corners  $\beta, \gamma$  and if  $g$  in  $\pi_1(M) - \text{id}$  satisfies  $g(\beta) = \beta, g(\gamma) = \gamma$  (and so  $g(\mathcal{C}) = \mathcal{C}$ ), then  $\pi(\beta), \pi(\gamma)$  are closed orbits of  $\Phi$  which are freely homotopic to the inverse of each other.

**Theorem 2.5.** ([Fe5], theorem 4.8) Let  $\Phi$  be a pseudo-Anosov flow in  $M$  closed and let  $F_0 \neq F_1 \in \widetilde{\Lambda}^s$ . Suppose that there is a non trivial covering translation  $g$  with  $g(F_i) = F_i, i = 0, 1$ . Let  $\alpha_i, i = 0, 1$  be the periodic orbits of  $\widetilde{\Phi}$  in  $F_i$  so that  $g(\alpha_i) = \alpha_i$ . Then  $\alpha_0$  and  $\alpha_1$  are connected by a finite chain of lozenges  $\{\mathcal{C}_i\}, 1 \leq i \leq n$  and  $g$  leaves invariant each lozenge  $\mathcal{C}_i$  as well as their corners.

The leaf space of  $\widetilde{\Lambda}^s$  (or  $\widetilde{\Lambda}^u$ ) is usually not a Hausdorff space. Two points of this space are non separated if they do not have disjoint neighborhoods in the respective leaf space. The main result concerning non Hausdorff behavior in the leaf spaces of  $\widetilde{\Lambda}^s, \widetilde{\Lambda}^u$  is the following:

**Theorem 2.6.** ([Fe5], theorem 4.9) Let  $\Phi$  be a pseudo-Anosov flow in  $M^3$ . Suppose that  $F \neq L$  are not separated in the leaf space of  $\widetilde{\Lambda}^s$ . Then  $F$  and  $L$  are periodic. Let  $F_0, L_0$  be the line leaves of  $F, L$  which are not separated from each other. Let  $V_0$  be the sector of  $F$  bounded by  $F_0$  and containing  $L$ . Let  $\alpha$  be the periodic orbit in  $F_0$  and  $H_0$  be the component of  $(\widetilde{W}^u(\alpha) - \alpha)$  contained in  $V_0$ . Let  $g$  be a non trivial

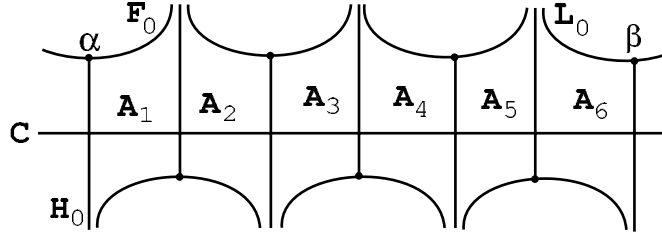

Figure 2: The correct picture between non separated leaves of  $\tilde{\Lambda}^s$ .

covering translation with  $g(F_0) = F_0$ ,  $g(H_0) = H_0$  and  $g$  leaves invariant the components of  $(F_0 - \alpha)$ . Then  $g(L_0) = L_0$ . This produces closed orbits of  $\Phi$  which are freely homotopic in  $M$ . Theorem 2.5 then implies that  $F_0$  and  $L_0$  are connected by a finite chain of lozenges  $\{A_i\}$ ,  $1 \leq i \leq n$ , consecutive lozenges are adjacent. They all intersect a common stable leaf  $C$ . There is an even number of lozenges in the chain, see fig. 2. In addition let  $\mathcal{B}_{F,L}$  be the set of leaves of  $\tilde{\Lambda}^s$  non separated from  $F$  and  $L$ . Put an order in  $\mathcal{B}_{F,L}$  as follows: The set of orbits of  $C$  contained in the union of the lozenges and their sides is an interval. Put an order in this interval. If  $R_1, R_2 \in \mathcal{B}_{F,L}$  let  $\alpha_1, \alpha_2$  be the respective periodic orbits in  $R_1, R_2$ . Then  $\tilde{W}^u(\alpha_i) \cap C \neq \emptyset$  and let  $a_i = \tilde{W}^u(\alpha_i) \cap C$ . We define  $R_1 < R_2$  in  $\mathcal{B}_{F,L}$  if  $a_1$  precedes  $a_2$  in the order of the set of orbits of  $C$ . Then  $\mathcal{B}_{F,L}$  is either order isomorphic to  $\{1, \dots, n\}$  for some  $n \in \mathbf{N}$ ; or  $\mathcal{B}_{F,L}$  is order isomorphic to the integers  $\mathbf{Z}$ . In addition if there are  $Z, S \in \tilde{\Lambda}^s$  so that  $\mathcal{B}_{Z,S}$  is infinite, then there is an incompressible torus in  $M$  transverse to  $\Phi$ . In particular  $M$  cannot be atoroidal. Also if there are  $F, L$  as above, then there are closed orbits  $\alpha, \beta$  of  $\Phi$  which are freely homotopic to the inverse of each other. Finally up to covering translations, there are only finitely many non Hausdorff points in the leaf space of  $\tilde{\Lambda}^s$ .

Notice that  $\mathcal{B}_{F,L}$  is a discrete set in this order. For detailed explanations and proofs, see [Fe4, Fe5].

### Scalloped regions

Suppose that  $\mathcal{E} = \{E_i \mid i \in \mathbf{Z}\}$  is a bi-infinite collection of leaves of  $\tilde{\Lambda}^s$  or  $\tilde{\Lambda}^u$  all of which are non separated from each other and ordered as in theorem 2.6. There is an associated structure in  $\tilde{M}$  or  $\mathcal{O}$ , which is called a scalloped region, which we now describe. Let  $\{A_i \mid i \in \mathbf{Z}\}$  be the bi-infinite collection of lozenges associated to  $\mathcal{E}$  – consecutive  $A_i$ 's are adjacent. For simplicity assume that  $\mathcal{E}$  is a collection of stable leaves, so that every  $A_i$  intersects a fixed stable leaf  $\zeta$ . The  $A_i$  are chosen so that each  $E_i$  has a half leaf in the boundary of  $A_{2i}$  and another half leaf in the boundary of  $A_{2i-1}$ . Each leaf  $E_i$  contains a periodic orbit  $\gamma_i$ . Let  $W_i$  be the half leaf of  $\tilde{W}^u(\gamma_i)$  which is in the boundary of both  $A_{2i}$  and  $A_{2i-1}$ . In addition since  $A_{2i}$  and  $A_{2i+1}$  are also adjacent there is a stable leaf  $G_i$  which has half leaves in the closure of each of  $A_{2i}$  and  $A_{2i+1}$ . Hence  $\{G_i \mid i \in \mathbf{Z}\}$  is another collection of leaves of  $\tilde{\Lambda}^s$  non separated from each other. Each  $G_i$  contains a periodic orbit  $\delta_i$  and  $\tilde{W}^u(\delta_i)$  has a half leaf  $Y_i$  which is in the closure of both  $A_{2i}$  and  $A_{2i+1}$ . The *scalloped region* associated to  $\mathcal{E}$  is

$$\mathcal{S} = \bigcup_{i \in \mathbf{Z}} (A_i \cup W_i \cup Y_i),$$

see fig. 3.

Scalloped regions were introduced for Anosov flows in section 5, theorem 5.2 of [Fe3], but the same analysis works for pseudo-Anosov flows, mainly because there can be no singularities in the lozenges [Fe4]. It is proved in [Fe3] that such a scalloped region  $\mathcal{S}$  (where the  $E_i$  are stable leaves) is also the union of another bi-infinite collection of lozenges  $\{B_i \mid i \in \mathbf{Z}\}$  and stable half leaves in the boundary of pairs of consecutive lozenges. All of the lozenges  $B_i$  intersect a fixed unstable leaf. Therefore the foliations  $\tilde{\Lambda}^s, \tilde{\Lambda}^u$  restricted to  $\mathcal{S}$  form a product structure in  $\mathcal{S}$ , they both have leaf space which is homeomorphic to  $\mathbf{R}$ . In this way the boundary  $\partial\mathcal{S}$  also has two bi-infinite collections of leaves of  $\mathcal{O}^u$ . In each collection all leaves are non separated from each other. Let  $\{S_j\}_{j \in \mathbf{Z}}$  be the collection which is in the limit of the sequence

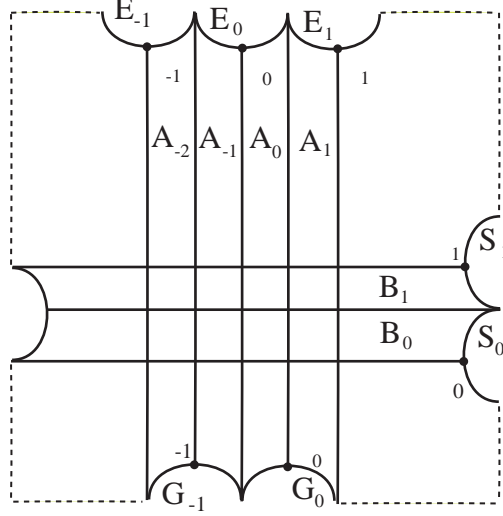

Figure 3: A scalloped region  $\mathcal{S}$ . The collections  $\{E_i\}_{i \in \mathbf{Z}}$ ,  $\{G_i\}_{i \in \mathbf{Z}}$  of stable leaves are part of the boundary of  $\mathcal{S}$ . In addition  $\{S_i\}_{i \in \mathbf{Z}}$  are unstable leaves in the boundary of  $\mathcal{S}$ . For better viewing we indent a few of the non separated leaves in (say)  $\{E_i\}_{i \in \mathbf{Z}}$  into the square. Similarly for  $\{G_i\}$ ,  $\{S_i\}$ .

$\widetilde{W}^u(\gamma_i)$  (or equivalently  $\widetilde{W}^u(\delta_i)$ ) when  $i$  converges to plus infinity. The other bi-infinite collection of unstable leaves is obtained as the limit of  $(\widetilde{W}^u(\gamma_i))$  as  $i$  converges to minus infinity. We may choose the indexing of the  $\{S_j\}$  so that  $S_j$  has one half leaf in the closure of  $B_{2j}$  and another in the closure of  $B_{2j-1}$ . Let  $\tau_j$  be the periodic orbit in  $S_j$ . We may also choose the indexing so that  $(\widetilde{W}^s(\tau_j))$  converges to the collection  $\{E_i\}_{i \in \mathbf{Z}}$  when  $i \rightarrow \infty$  and  $(\widetilde{W}^s(\tau_j))$  converges to  $\{G_i\}_{i \in \mathbf{Z}}$  when  $i \rightarrow -\infty$ . We also call a scalloped region the projection of  $\mathcal{S}$  to the orbit space  $\mathcal{O}$ .

Here is an actual model for a scalloped region in  $\mathcal{O}$ . Let  $I, J$  be two properly embedded, order preserving images of  $\mathbf{Z}$  into  $(-1, 1)$  which are intercalated, for example  $J = \{\pm(1 - \frac{1}{2n}) \mid n \geq 1\}$  and  $I = \{\pm(1 - \frac{1}{2n-1}) \mid n \geq 1\}$ . The closure of a scalloped region is a proper embedding of the set

$$V = ([-1, 1] \times [-1, 1]) - \left( (J \times \{1\}) \cup (\{1\} \times J) \cup (I \times \{-1\}) \cup (\{-1\} \times I) \cup (\{-1, 1\} \times \{-1, 1\}) \right)$$

into  $\mathcal{O}$  satisfying the following conditions: The horizontal and vertical foliations of  $\mathbf{R}^2$  restricted to  $V$  are mapped to the stable and unstable foliations in  $\overline{\mathcal{S}}$ . The interior of  $V$  maps to the scalloped region. It is crucial that  $I, J$  do not intersect. For example the stable leaf  $(-1/2, 1/2) \times \{1\}$  is one of the  $E_i$ , we may assume that it is  $E_0$ . Then  $(0, 1)$  is the periodic orbit  $\gamma_0$  and  $\{0\} \times (-1, 1)$  is the half leaf of  $\widetilde{W}^u(\gamma_0)$  which is in the boundary of the lozenges  $A_{-1} = (-1/2, 0) \times (-1, 1)$  and  $A_0 = (0, 1/2) \times (-1, 1)$ . It is crucial in this particular example that  $(0, -1)$  is not in  $V$ . We may assume that  $S_0 = \{1\} \times (-1/2, 1/2)$ .

In fig. 3 we indent the region along the boundary stable and unstable leaves to highlight that they form collections of non separated leaves.

**Theorem 2.7.** ([Fe5], theorem 4.10) *Let  $\Phi$  be a pseudo-Anosov flow. Suppose that there is a stable or unstable product region. Then  $\Phi$  is topologically conjugate to a suspension Anosov flow. In particular  $\Phi$  is nonsingular.*

### 3 Ideal boundaries of pseudo-Anosov flows

Let  $\Phi$  be a pseudo-Anosov flow in  $M$ . The orbit space  $\mathcal{O}$  of  $\widetilde{\Phi}$  (the lifted flow to  $\widetilde{M}$ ) is homeomorphic to  $\mathbf{R}^2$  [Fe-Mo]. In this section we construct a natural compactification of  $\mathcal{O}$  with an ideal circle  $\partial\mathcal{O}$  called the ideal boundary of the pseudo-Anosov flow. We put a topology in  $\mathcal{D} = \mathcal{O} \cup \partial\mathcal{O}$  making it homeomorphic

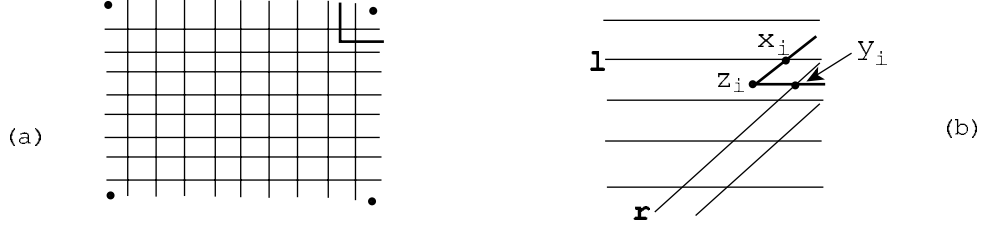

Figure 4: Ideal points for product  $\mathbf{R}$ -covered Anosov flow, the dots represent the 4 special points, b. The picture in skewed case.

to a closed disk. The induced action of  $\pi_1(M)$  on  $\mathcal{O}$  extends to an action on  $\mathcal{O} \cup \partial\mathcal{O}$ . This works for any pseudo-Anosov flow in a 3-manifold – no metric, or topological assumptions (such as atoroidal) on  $M$  or on the flow  $\Phi$ . In addition there are no assumptions about perfect fits for  $\Phi$  or concerning topological conjugacy to suspension Anosov flows.

One key aspect here is that we want to use only the foliations  $\mathcal{O}^s, \mathcal{O}^u$  to define  $\partial\mathcal{O}$  and its topology.

Before formally defining ideal points of  $\mathcal{O}$  we analyse some examples. Given  $g$  in  $\pi_1(M)$  it acts on  $\widetilde{M}$  and sends flow lines of  $\widetilde{\Phi}$  to flow lines and hence acts on  $\mathcal{O}$ . This action preserves the foliations  $\widetilde{\Lambda}^s, \widetilde{\Lambda}^u, \widetilde{\mathcal{O}}^s, \widetilde{\mathcal{O}}^u$ . Recall that a 2-dimensional foliation  $\mathcal{F}$  in a 3-manifold  $N$  is called  $\mathbf{R}$ -covered if the leaf space of  $\mathcal{F}$  is homeomorphic to the real line [Fe1]. An Anosov flow is  $\mathbf{R}$ -covered if  $\Lambda^s$  (or equivalently  $\Lambda^u$  [Ba1]) is  $\mathbf{R}$ -covered.

1) Ideal boundary for  $\mathbf{R}$ -covered Anosov flows. The product case.

A product Anosov flow is an Anosov flow for which both  $\Lambda^s, \Lambda^u$  are  $\mathbf{R}$ -covered and in addition every leaf of  $\mathcal{O}^s$  intersects every leaf of  $\mathcal{O}^u$  and vice versa [Fe1, Ba1]. Barbot proved that this implies that  $\Phi$  is topologically conjugate to a suspension [Ba1]. Every ray in  $\mathcal{O}^s$  or  $\mathcal{O}^u$  generates a point of  $\partial\mathcal{O}$  and they are all distinct. Furthermore there are 4 additional ideal points corresponding to escaping quadrants in  $\mathcal{O}$ , see fig. 4, a. The quadrants are bounded by a ray in  $\mathcal{O}^u$  and a ray in  $\mathcal{O}^s$  which intersect only in their common starting point (or finite endpoints). In this case it is straightforward to put a topology in  $\mathcal{D} = \mathcal{O} \cup \partial\mathcal{O}$  so that it is a closed disk and covering transformations act on the extended object. If  $\Lambda^s, \Lambda^u$  are both transversely orientable, then any covering translation  $g$  fixes the 4 distinguished points. It is associated to a periodic orbit if and only if it fixes 4 additional ideal points: if  $x$  in  $\mathcal{O}$  satisfies  $g(x) = x$ , then  $g$  fixes the “ideal points” of rays of  $\mathcal{O}^s(x), \mathcal{O}^u(x)$ . When  $\Lambda^s, \Lambda^u$  are not transversely orientable, there are other restricted possibilities.

We want to define a topology in  $\mathcal{D}$  using only the structure of  $\mathcal{O}^s, \mathcal{O}^u$  in  $\mathcal{O}$ . A distinguished ideal point  $p$  has a neighborhood basis determined by (say nested) pairs of rays in  $\mathcal{O}^s, \mathcal{O}^u$  intersecting at their common finite endpoint and so that the corresponding quadrants “shrink” to  $p$ . For an ordinary ideal point  $p$ , say a stable ideal point of a ray in  $\mathcal{O}^s(x)$ , we can use shrinking strips: the strips are bounded by 2 rays in  $\mathcal{O}^s$  and a segment in  $\mathcal{O}^u$  connecting the endpoints of the rays. The unstable segment intersects the original stable ray of  $\mathcal{O}^s(x)$  and the intersections escape in that ray and also shrink in the transversal direction. Already in this case this leads to an important concept:

**Definition 3.1.** (*polygonal path*) A polygonal path in  $\mathcal{O}$  is a properly embedded, bi-infinite path  $\zeta$  in  $\mathcal{O}$  satisfying: either  $\zeta$  is a leaf of  $\mathcal{O}^s$  or  $\mathcal{O}^u$  or  $\zeta$  is the union of a finite collection  $l_1, \dots, l_n$  of segments and rays in leaves of  $\mathcal{O}^s$  or  $\mathcal{O}^u$  so that  $l_1$  and  $l_n$  are rays in  $\mathcal{O}^s$  or  $\mathcal{O}^u$  and the other  $l_i$  are finite segments. We require that  $l_i$  intersects  $l_j$  if and only if  $|i - j| \leq 1$ . In addition the  $l_i$  are alternatively in  $\mathcal{O}^s$  and  $\mathcal{O}^u$ . The number  $n$  is the length of the polygonal path. The points  $l_i \cap l_{i+1}$  are the vertices of the path. The edges of  $\zeta$  are the  $\{l_i\}$ .

In the product  $\mathbf{R}$ -covered case, the exceptional ideal points need neighborhoods basis formed by polygonal paths of length 2 and all the others need polygonal paths of length 3.

2)  $\mathbf{R}$ -covered Anosov flows – skewed case.

This is an Anosov flow so that  $\Lambda^s, \Lambda^u$  are  $\mathbf{R}$ -covered and the following is satisfied: Topologically the orbit space  $\mathcal{O}$  is homeomorphic to  $(0, 1) \times \mathbf{R}$ , a subset of the plane, so that stable leaves are horizontal segments and unstable leaves are segments making a constant angle  $\neq \pi/2$  with the horizontal, see fig. 4, b. A leaf of  $\mathcal{O}^s$  does not intersect every leaf of  $\mathcal{O}^u$  and vice versa [Fe1, Ba2]. Here again each ray of  $\mathcal{O}^s$  or  $\mathcal{O}^u$  defines an ideal point of  $\mathcal{O}$ . However as is intuitive from the picture, rays of  $\mathcal{O}^s, \mathcal{O}^u$  which form a perfect fit in  $\mathcal{O}$  should define the same ideal point of  $\mathcal{O}$ . In addition to these ideal points of rays of leaves in  $\mathcal{O}^s$  or  $\mathcal{O}^u$ , there should be 2 distinguished ideal points – one from the “positive” direction of  $\mathbf{R}$  and one from the “negative” direction of  $\mathbf{R}$ . Hence  $\mathcal{D}$  is equal to  $[0, 1] \times \mathbf{R}$  union two points: one for the positive end of  $\mathbf{R}$  and one for the negative end. Put a topology in  $\mathcal{D}$  so that  $[0, 1] \times \mathbf{R}$  is homeomorphic to a disk minus two boundary points. Covering translations act as homeomorphisms of this disk. A transformation without fixed points in  $\mathcal{O}$  fixes only the 2 distinguished ideal points in  $\partial\mathcal{O}$ , one attracting and another repelling. If a transformation  $g$  has a fixed point  $p$  in  $\mathcal{O}$ , then it leaves invariant the leaf  $l = \mathcal{O}^s(p)$  of  $\mathcal{O}^s$ . If  $g$  switches the components of  $l - \{p\}$ , then  $g$  does not fix any point in  $\partial\mathcal{O}$ . Otherwise there are infinitely many fixed points, see [Fe1, Ba2].

A neighborhood basis of the distinguished ideal points can be obtained from leaves of  $\mathcal{O}^s$  or  $\mathcal{O}^u$  which escape in that direction (positive or negative). For non distinguished ideal points, we get sequences of polygonal paths of length 2 escaping every compact set and “converging” to this ideal point, see fig. 4, b. More precisely if rays  $l, r$  of  $\mathcal{O}^s, \mathcal{O}^u$  respectively form a perfect fit defining the ideal point  $p$ , then choose  $x_i$  in  $l$  and escaping in the direction of the perfect fit and similarly chose  $y_i$  in  $r$ . Consider the polygonal path of length two containing rays in the stable leaf through  $y_i$  and the unstable leaf through  $x_i$  (intersecting in  $z_i$ , see fig. 4, b).

### 3) Suspension pseudo-Anosov flows – singular case.

The fiber is a hyperbolic surface. The orbit space  $\mathcal{O}$  is identified with the universal cover of the fiber which is metrically the hyperbolic plane  $\mathbf{H}^2$ . There is a natural ideal boundary  $S_\infty^1$  – the circle at infinity of  $\mathbf{H}^2$ . One expects that  $\partial\mathcal{O}$  and  $S_\infty^1$  should be the equivalent. But the construction of  $S_\infty^1$  uses the metric structure on the surface – in general there is no metric structure in  $\mathcal{O}$ , so again we want to define  $\partial\mathcal{O}$  using only the structure of  $\mathcal{O}^s, \mathcal{O}^u$ . From a geometric point of view, there are some points of  $S_\infty^1$  which are ideal points of rays of leaves of  $\mathcal{O}^s$  or  $\mathcal{O}^u$ . But there are many other points in  $S_\infty^1$ . The foliations  $\mathcal{O}^s, \mathcal{O}^u$  can be split into geodesic laminations (of  $\mathbf{H}^2$ ) which have only complementary regions which are finite sided ideal polygons. This implies that given  $p$  in  $S_\infty^1$  there is always a sequence of leaves  $l_i$  (in  $\mathcal{O}^s$  or  $\mathcal{O}^u$ ) which is nested, escapes to infinity and “shrinks” to the ideal point  $p$ . In this way one can characterize all points of  $S_\infty^1$  using only the foliations  $\mathcal{O}^s, \mathcal{O}^u$  and hence  $\partial\mathcal{O} = S_\infty^1$  in this case. Also  $\mathcal{O}^s, \mathcal{O}^u$  define a topology in  $\mathcal{O} \cup \partial\mathcal{O}$  compatible with the metric topology.

Now we analyse a potential difficulty. Let  $l$  be a nonsingular ray (say) in  $\mathcal{O}^s$  and let  $x_i$  in  $l$ , forming a nested sequence of points in  $l$ , escaping compact sets in  $l$ . For simplicity assume that the leaves  $g_i$  of  $\mathcal{O}^u$  through  $x_i$  are nonsingular. We would like to say that the sequence  $(g_i)$  “defines” an ideal point of  $\mathcal{O}$ . If the  $g_i$  escape compact sets in  $\mathcal{O}$ , then this will be the case. However it is not always true that  $(g_i)$  escapes in  $\mathcal{O}$ . If they do not escape in  $\mathcal{O}$ , then they limit on a collection of unstable leaves  $\{h_j \mid j \in J\}$ . But there is one of them, call it  $h$  which makes a perfect fit with  $l$  on that side of  $l$ . This non trivial fact is proved in [Fe4]. The perfect fit  $l, h$  is the obstruction to leaves  $g_i$  escaping in  $\mathcal{O}$ .

We need a couple of definitions. A *quarter* at  $z$  is a component of  $\mathcal{O} - (\mathcal{O}^s(z) \cup \mathcal{O}^u(z))$ . If  $z$  is nonsingular there are exactly 4 quarters, if  $z$  is a  $k$ -prong point there are  $2k$  quarters.

**Definition 3.2.** (*convex polygonal paths*) A polygonal path  $\delta$  in  $\mathcal{O}$  is convex if there is a complementary region  $V$  of  $\delta$  in  $\mathcal{O}$  so that at any given vertex  $z$  of  $\delta$  the local region of  $V$  near  $z$  is not a quarter at  $z$ . Let  $\tilde{\delta} = \mathcal{O} - (\delta \cup V)$ . This region  $\tilde{\delta}$  is the convex region of  $\mathcal{O}$  associated to the convex polygonal path  $\delta$ .

The definition implies that if the region  $\tilde{\delta}$  contains 2 endpoints of a segment in a leaf of  $\mathcal{O}^s$  or  $\mathcal{O}^u$ , then it contains the entire segment (proved later). This is why  $\delta$  is called convex. If  $\delta$  is a single nonsingular leaf of  $\Lambda^s$  or  $\Lambda^u$  or if all the vertices of  $\delta$  are singularities, then it is possible that there are two regions

$\tilde{\delta}$  which are convex. In the future the context will make clear which region we are considering. If  $\delta$  is a polygonal path,  $V$  a complementary region and  $p$  a vertex for which  $V$  is a quarter at  $p$ , then  $p$  is called a non convex vertex of  $\mathcal{O} - (\delta \cup V)$ .

**Definition 3.3.** (*equivalent rays*) Two rays  $l, r$  of  $\mathcal{O}^s, \mathcal{O}^u$  are equivalent if there is a finite collection of distinct rays  $l_i, 1 \leq i \leq n$ , alternatively in  $\mathcal{O}^s, \mathcal{O}^u$  so that  $l = l_0, r = l_n$  and  $l_i$  forms a perfect fit with  $l_{i+1}$  for  $1 \leq i < n$ .

It is important to notice that this is strictly about rays in  $\mathcal{O}^s, \mathcal{O}^u$  and not leaves of  $\mathcal{O}^s, \mathcal{O}^u$ . More specifically we want consecutive perfect fits to be in the same rays of the adjoining leaf. This implies for instance that if  $n \geq 3$  then for all  $1 \leq i \leq n - 2$  the leaves  $l_i$  and  $l_{i+2}$  are non separated from each other in the respective leaf space.

**Definition 3.4.** (*admissible sequences of paths*) An admissible sequence of polygonal paths in  $\mathcal{O}$  is a sequence of convex polygonal paths  $(v_i)_{i \in \mathbf{N}}$  so that the associated convex regions  $\tilde{v}_i$  form a nested sequence of subsets of  $\mathcal{O}$ , which escapes compact sets in  $\mathcal{O}$  and for any  $i$ , the two rays at the ends of  $v_i$  are not equivalent.

The fact that the  $\tilde{v}_i$  are nested and escape compact sets in  $\mathcal{O}$  implies that the  $\tilde{v}_i$  are uniquely defined given the  $v_i$ .

**Structure of this section** – The construction of the ideal compactification of  $\mathcal{O}$  and the analysis of its properties is very involved and complex. This will take all of this very long section, so here is an outline of the section: Ideal points of  $\mathcal{O}$  will be defined by admissible sequences of polygonal paths, definition 3.10. But many admissible sequences generate the same ideal point, so we first define a relation in the set of admissible sequences, definition 3.5. We establish a technical result called the fundamental lemma (lemma 3.6) which implies that the relation above is an equivalence relation, lemma 3.7. In definition 3.10 we define ideal points of  $\mathcal{O}$  producing  $\partial\mathcal{O}$  and with union  $\mathcal{D} = \mathcal{O} \cup \partial\mathcal{O}$ . Some special ideal points are defined in definition 3.8 associated to ideal points of rays of  $\mathcal{O}^s$  or  $\mathcal{O}^u$  and in lemma 3.27 we deal with infinitely many leaves of  $\mathcal{O}^s$  or  $\mathcal{O}^u$  all non separated from each other. Not every admissible sequence is efficient to study ideal points of  $\mathcal{O}$  and we define master sequences in definition 3.11: roughly the rays in the polygonal paths of these sequences approach the ideal point of  $\mathcal{O}$  from “both” sides. In lemma 3.13 we prove that any ideal point admits a master sequence and they are used to distinguish points of  $\partial\mathcal{O}$ . In definition 3.15 we define a topology for  $\mathcal{D} = \mathcal{O} \cup \partial\mathcal{O}$  and in lemma 3.16 we prove that this is indeed a topology in  $\mathcal{D}$ . We then progressively prove stronger properties of  $\mathcal{D}$ : Lemma 3.19 shows that  $\mathcal{D}$  is Hausdorff, lemma 3.23 shows that  $\mathcal{D}$  is first countable and lemma 3.24 shows that  $\mathcal{D}$  is second countable - this last one is a bit more complicated than the other ones. These and the structure of  $\mathcal{D}$  quickly imply that  $\mathcal{D}$  is regular (lemma 3.25) and hence metrizable. Then we study compactness properties: first we prove a technical and very tricky lemma about a special case (lemma 3.28). This lemma considerably simplifies the proof of compactness of  $\mathcal{D}$  (proposition 3.29). At this point we can quickly prove that the ideal boundary  $\partial\mathcal{O}$  is homeomorphic to a circle (proposition 3.30). We then prove a harder result (theorem 3.31) that  $\mathcal{D} = \mathcal{O} \cup \partial\mathcal{O}$  is homeomorphic to a closed disk. Finally in lemmas 3.20, 3.22, 3.27 and proposition 3.33 we prove additional properties of the ideal points of  $\mathcal{O}$  and which types of admissible sequences are associated to different types of ideal points.

An ideal point of  $\mathcal{O}$  will be determined by an admissible sequence of paths. Clearly this does not work for suspension Anosov flows because a sequence of escaping leaves of  $\mathcal{O}^s$  approaches infinitely many different ideal points. Hence such flows are special and are treated separately. We abuse notation and say that  $(v_i)_{i \in \mathbf{N}}$  is nested. For notational simplicity many times we denote such a sequence by  $(v_i)$ .

Two different admissible sequences may define the same ideal point and we first need to decide when two such sequences are equivalent. At first it seems that any 2 sequences associated to the same ideal point of  $\mathcal{O}$  would have to be eventually nested with each other. However it is easy to see that such is not the case. For example consider a nested sequence of rays of a fixed leaf  $l$ . We will later see how to

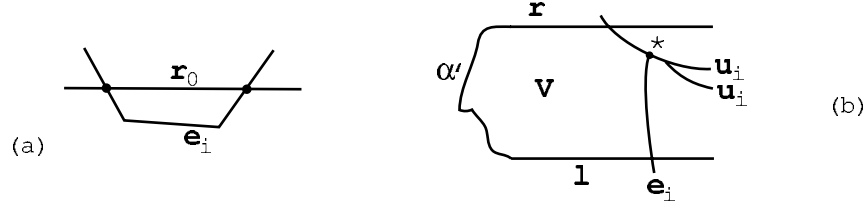

Figure 5: *a. Convexity implies connected intersection of  $r$  and  $B_i$ . b. All rays of  $u_i$  stay in  $V$  forever. There is a non convex vertex at  $*$ .*

extend each ray on one side of  $l$  to form an admissible sequence. Extend them also to the other side to form another admissible sequence. Intuitively the two sequences should converge to the intrinsic ideal point of  $l$ , but clearly they are not eventually nested.

**Definition 3.5.** *Given two admissible sequences of chains  $C = (c_i)$ ,  $D = (d_i)$ , we say that  $C$  is smaller or equal than  $D$ , denoted by  $C \leq D$ , if: for any  $i$  there is  $k_i > i$  so that  $\tilde{c}_{k_i} \subset \tilde{d}_i$ . Two admissible sequences of chains  $C = (c_i)$ ,  $D = (d_i)$  are equivalent and we then write  $C \cong D$  if there is a third admissible sequence  $E = (e_i)$  so that  $C \leq E$  and  $D \leq E$ .*

Ideal points of  $\mathcal{O}$  will be defined as equivalence classes of admissible sequences of polygonal paths. Hence we must prove that  $\cong$  is an equivalence class and along the way we derive several other properties. We should stress that the requirement that the chains are convex is fundamental for the whole discussion. It is easy to see in the skewed  $\mathbf{R}$ -covered Anosov case, that given any two distinct ideal points  $p, q$  on the “same side” of the distinguished ideal points, the following happens: Let  $l, r$  be stable rays defining  $p, q$  respectively. Then there is a sequence of polygonal paths in  $\mathcal{O}$ , that escapes compact sets in  $\mathcal{O}$  and so that each  $\tilde{c}_i$  contains subrays of both  $l$  and  $r$ . The polygonal paths can be chosen to satisfy all the properties, except that they are convex. On the other hand convexity does imply important properties as shown in the next lemma. This key lemma will be used throughout this section. After this lemma we show that  $\cong$  is an equivalence relation.

**Singular foliations in surfaces with boundary and index formula**

Let  $\mathcal{F}$  be a singular foliation on a compact surface  $S$  with boundary, so that interior singularities are all of  $k$ -prong type and  $k \geq 3$ . The foliation may be tangent to part of the boundary. There is an Euler-Poincare index formula so that the sum of the indices of the singularities equals the Euler characteristic of the surface. An interior singularity with  $k$  prongs has index  $1 - \frac{k}{2}$ . A boundary singularity has index  $\frac{1}{2} - \frac{k}{2} - \frac{t}{4}$ , where  $k$  is the number of prongs going into the surface and  $t$  is the number of prongs which are part of the boundary. The possible values of  $t$  are 0, 1, 2. For example if  $k = 0, t = 0$  the singularity is half of a center, which has index 1/2. This will be used for compact subsets of  $\mathcal{O}$ , which are foliated by  $\mathcal{O}^s$  or  $\mathcal{O}^u$ .

**Lemma 3.6.** *(fundamental lemma) Assume that  $\Phi$  is not topologically conjugate to a suspension Anosov flow. Let  $l, r$  be rays of  $\mathcal{O}^s$  or  $\mathcal{O}^u$ , which are not equivalent. Then there is no pair of admissible sequence of polygonal paths  $E = (e_i)$ ,  $F = (f_i)$  so that:  $\tilde{e}_i \cap \tilde{f}_i \neq \emptyset$  (for all  $i$ ) and  $\tilde{e}_i \cap r \neq \emptyset$ ,  $\tilde{f}_i \cap l \neq \emptyset$ , for all  $i$ .*

*Proof.* We assume that both  $l$  and  $r$  are rays of  $\mathcal{O}^s$ , other cases are treated similarly. By taking subrays if necessary, we may assume that  $l, r$  are disjoint, have no singularities and miss a compact set containing the base point in  $\mathcal{O}$ . Join the initial points of  $l, r$  by an arc  $\alpha'$  missing this big compact set to produce a properly embedded bi-infinite curve  $\alpha = l \cup \alpha' \cup r$ , see fig. 5, b. Let  $V$  be the component of  $\mathcal{O} - \alpha$  which misses the basepoint.

Case 1 –  $E = F$ .

Here we have to show that there is no admissible sequence of polygonal paths  $E = (e_i)$  such that  $\tilde{e}_i$  always intersects  $l$  and  $r$ . This implies that the phenomenon described above (in the skewed Anosov flow



case) for non convex polygonal paths cannot happen for convex polygonal paths. Suppose this is not true and let  $E = (e_i)$  be one such sequence. Let  $B_i = \tilde{e}_i \cup e_i$ .

Claim 1 – If  $e_i$  is a convex polygonal path with region  $\tilde{e}_i$  and  $r$  is a leaf of  $\mathcal{O}^s$  (or of  $\mathcal{O}^u$ ), then  $(\tilde{e}_i \cup e_i) \cap r$  is connected.

Otherwise there is a compact subarc  $r_0$  of  $r$  with  $\partial r_0$  in  $e_i$  and the rest of  $e_i$  contained in  $\mathcal{O} - B_i$ , see fig. 5, a. There is a compact arc  $\tau$  in  $e_i$  joining the endpoints  $x, y$  of  $r_0$ . Let  $D$  be the disc in  $\mathcal{O}$  bounded  $r_0 \cup \tau$  and consider the foliation  $\mathcal{O}^s$  induced in  $D$ . The singularities in the interior are  $k$  prong type all with negative index. At  $x$  there is a boundary prong of  $\mathcal{O}^s$  (since  $r_0$  is in the boundary of  $D$ ) so the index is  $\leq 1/4$  and similarly for  $y$ . If there are singularities in the interior of  $r_0$  then they have negative index as  $r_0$  is contained in a leaf of  $\mathcal{O}^s$ . Since the Euler characteristic of the disc is 1 and there are no half centers in  $\tau$ , all singularities in  $\tau$  have index  $\leq 1/4$ . It follows that there must be at least two boundary singularities in  $\tau - \{x, y\}$  with index  $1/4$ . Each one of these has to be a point  $z$  so that there is a prong of  $\mathcal{O}^s$  and a prong of  $\mathcal{O}^u$  locally contained in  $\tau \subset \partial D$  and no other prongs of  $\mathcal{O}^s \cup \mathcal{O}^u$  entering  $D$ . The unstable prong is transverse to  $\mathcal{O}^s$ . This shows there is a quarter of  $D$  at  $z$ . But since  $r_0 - \{x, y\} \subset (\mathcal{O} - B_i)$  this means that  $\tilde{e}_i$  has a non convex vertex at  $z$ , contradiction to  $e_i$  being convex. Therefore  $B_i \cap r$  is connected and this proves claim 1. This is the convexity property of  $\tilde{e}_i$  mentioned after definition 3.2.

We continue the analysis of case 1. Notice that  $(B_j \cap r)_{j \in \mathbf{N}}$  is a nested family of non empty sets in  $r$ . Since  $B_j$  escapes compact sets as  $j \rightarrow \infty$  and  $B_j \cap r$  is connected, it follows that  $B_j \cap r$  is a subray of  $r$  for any  $j$ . If  $e_j \cap r$  contains a non trivial segment, then again by convexity and Euler characteristic it follows that  $\tilde{e}_j \cap r = \emptyset$  contradiction. Hence  $e_i$  intersects  $r$  in a single point. Let  $u'_i = \mathcal{O}^u(e_i \cap r)$  be the unstable leaf through the intersection. Up to subsequence, we may assume no two  $u'_i$  are the same.

Since  $r$  has no singularities there are two components of  $u'_i - (u'_i \cap r)$ . There is only one of them denoted by  $u_i$  which locally enters  $V$  at the intersection, see fig. 5, b. There are two subcases:

Case 1.a – Some ray of  $u_i$  stays in  $V$  for all time.

Let this ray be  $s$ . Then  $s$  is properly embedded in  $V$  and together with a subray of  $r$  it bounds a subregion  $W$  of  $V$ . It follows that by taking a bigger  $i$  if necessary we may assume that all rays of  $u_i$  stay in  $V$  forever – because they are in the region  $W$  above. Take the ray  $s$  of  $u_i$  starting at  $u'_i \cap r$  and farthest from  $r$  or equivalently closest to  $l$ . Even though  $r, l$  are rays and do not separate  $\mathcal{O}$ , this makes sense because  $V$  is an open disc with boundary  $\alpha$  and  $l, r$  are disjoint subrays of  $\alpha$ . All rays of  $u_i$  start in  $r$  and the collection of rays of  $u_i$  is (weakly) nested.

In that case, in order for  $e_i$  to reach  $l$  it leaves  $s$  at a point  $*$  where  $e_i$  switches to travel along a segment  $t$  in  $\mathcal{O}^s$ . There cannot be any other prong of  $\mathcal{O}^s(*) \cup \mathcal{O}^u(*)$  not in  $\tilde{e}_i$ : since  $s$  is an unstable prong and  $t$  is contained in a stable prong, there would have to be another unstable prong in  $\tilde{e}_i$ . But this unstable prong is contained in  $V$  by construction and hence not contained in  $\tilde{e}_i$ . Hence this shows that  $*$  is a non convex vertex in  $e_i$ , see fig. 5, b. This is a contradiction to  $e_i$  convex.

Case 1.b – For any  $i$ , all rays of  $u_i$  exit  $V$ .

We first want to show that the sequence  $u_i$  does not escape compact sets in  $\mathcal{O}$ . Then we show that a leaf  $u$  in the limit of  $(u_i)$  has a ray which makes a perfect fit with  $r$  and we restart the proof with  $u, l$  in place of the rays  $r, l$ .

Suppose first that all  $u_i$  intersect  $l$ . In that case let  $z_i$  be the part of  $u_i$  between  $l$  and  $r$ . If the  $z_i$  escapes compact sets in  $\mathcal{O}$ , then the region between  $l$  and  $r$  is an unstable product region as in Definition 2.4. Theorem 2.7 then implies that  $\Phi$  is topologically conjugate to a suspension Anosov flow. This is disallowed by hypothesis (in fact the lemma fails for product  $\mathbf{R}$ -covered Anosov flows). Hence the  $u_i$  does not escape compact sets in  $\mathcal{O}$ . The other option is that the  $u_i$  does not intersect  $l$  – hence they intersect  $\alpha'$ . Since  $\alpha'$  is compact, then in all cases  $u_i$  does not escape compact sets in  $\mathcal{O}$ .

The intersection of  $\bar{u}_i$  with  $r$  escapes in  $r$ , and  $(u_i)$  is a nested collection (as subsets of  $V$ ), so  $u_i$  converges to a collection of (line) leaves of  $\mathcal{O}^u$ . Let  $u$  be one of the limit leaves. Consider the set  $B$  of

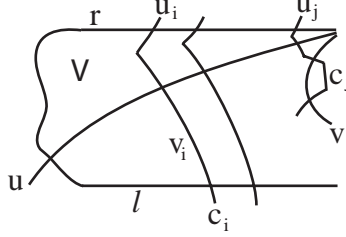

Figure 6: *Two polygonal chains and perfect fits.*

unstable leaves non separated from  $u$  and which are either contained in  $V$  or intersect  $\alpha$ . By theorem 2.6 there is an order in the set  $B$  and there are only finitely many unstable leaves between any given  $u$  and  $r$ , so we may assume that  $u$  is the leaf in  $B$  which is the closest one to  $r$  in terms of this order.

Claim 2 –  $u$  makes a perfect fit with  $r$ .

Suppose that  $u$  does not make a perfect fit with  $r$ . We will produce a product region. Let  $z$  a point in  $u$ . The stable leaf through  $z$  intersects  $u_i$  for a fixed  $i$  big. For any other  $w$  in  $u$  then  $\mathcal{O}^s(w)$  intersects  $u_j$  for some  $j > i$ . We say that  $w$  is closer to  $r$  than  $z$  if the intersections  $\mathcal{O}^s(z) \cap u_j, \mathcal{O}^s(w) \cap u_j, \bar{u}_j \cap r$  are linearly ordered in  $u_j'$ . Hence  $\mathcal{O}^s(w)$  also intersects the fixed  $u_i$ . It follows that as  $w$  escapes in  $u$  in the direction of  $r$ , the  $\mathcal{O}^s(w)$  converge to a stable leaf  $r'$  which makes a perfect fit with  $u$ . Hence  $r, r'$  are distinct. The region between  $r, r'$  is a product region because all the  $u_j$  ( $j \geq i$ ) intersect  $r, r'$  and there are no limit leaves of the  $(u_j)$  between  $r, r'$ . As seen above, this would imply  $\Phi$  is topologically conjugate to a suspension Anosov flow, contradiction. This proves claim 2.

The rest of case 1 concerns only flows with perfect fits.

We now show that  $u$  is not contained in  $V$ . If  $u$  is contained in  $V$ , there are two cases: i)  $u \subset \tilde{e}_i$  for all  $i$  – but this contradicts that  $\tilde{e}_i$  escapes compact sets of  $\mathcal{O}$ ; ii) there is  $i$  with  $u$  not contained in  $\tilde{e}_i$ . But then  $e_i$  has to cross  $u$ , and since  $u$  is contained in  $V$ , then  $e_i$  has to cross  $u$  again in order to intersect  $l$ . This produces two intersections of  $e_i$  with  $u$ , which is disallowed by claim 1.

It follows that there is a ray of  $u$  exiting  $V$ . We now restart the argument with  $u, l$  instead of  $r, l$ . The same arguments as above produce a line leaf  $v_1$  of  $\mathcal{O}^s$  making a perfect fit with  $u$  and  $v_1$  exiting  $V$ . In addition  $v_1$  is non separated from  $r$  in the leaf space of  $\mathcal{O}^s$  – because of the perfect fits  $r \rightarrow u \rightarrow v_1$ . Now iterate to obtain  $v_2, v_3, \dots$ . This is a nested collection and the sequence  $v_j$  cannot accumulate anywhere in  $\mathcal{O}$ , since  $v_k, v_{k+2}$  are non separated from each other in the corresponding leaf space. In addition no two consecutive unstable leaves in the sequence can intersect  $l$  as they are non separated from each other. It follows that none of them intersect  $l$  and so they all intersect  $\alpha'$ , which is compact. This contradicts the fact that they escape in  $\mathcal{O}$ . This proves that no escaping sequence of convex polygonal paths can always intersect both  $l$  and  $r$ . This finishes the analysis of Case 1.

Case 2 –  $E \neq F$ .

Let  $r, l$  as in the statement of the lemma and suppose that  $E = (e_i), F = (f_i)$  are admissible sequences with  $\tilde{e}_i \cap \tilde{f}_i \neq \emptyset, r \cap \tilde{e}_i \neq \emptyset, l \cap \tilde{f}_i \neq \emptyset$ , for all  $i$ . As before consider the region  $V$  bounded by  $l, r$  and an arc  $\alpha'$  connecting them. By case 1,  $\tilde{e}_i$  eventually stops intersecting  $l$ . Discarding the initial terms we can assume that  $\tilde{e}_i \cap l = \emptyset$  and  $\tilde{f}_i \cap r = \emptyset$  for all  $i$ .

We construct a polygonal path  $c_i$  as follows: first consider the part of  $e_i$  outside of  $V$ . Then add the edges (or pieces of edges) of  $e_i$  until it first meets  $f_i$ , then switch to  $f_i$  and follow along the rest of  $f_i$  in the direction that intersects  $l$ . There is only one such direction as  $f_i$  intersects  $l$  in a single point and notice that  $e_i$  does not intersect  $l$ . This path  $c_i$  separates  $\mathcal{O}$  and has a complementary component  $\tilde{c}_i$  which contains subrays of  $l, r$ . This component contains all of  $V$  except for a subset contained in a compact set of  $\mathcal{O}$ .

The vertices of  $c_i$  are all convex for  $\tilde{c}_i$ , except perhaps for the single vertex  $p_i$  where  $c_i$  changes from

$e_i$  to  $f_i$ . Once the non convex vertex appears, all subsequent vertices have to be convex.

As before consider the unstable leaf  $u_i$  through  $e_i \cap r$ . If some  $u_i$  has a ray which is entirely in  $V$ , then as seen in case 1, for  $j > i$  all rays of  $u_j$  which enter  $V$  must be entirely in  $V$ . This implies that the change from  $e_i$  to  $f_i$  has to be in  $u_i$ . Here is why: otherwise the next edge in  $c_i$  is  $w_i$  an edge still in  $e_i$ . But since  $c_i$  eventually has to cross  $l$ , and  $u_i$  is entirely contained in  $V$ , it follows that  $c_i$  has to intersect  $u_i$  at twice. As seen in the proof of claim 1, this implies the existence of two non convex vertices in  $c_i$ . But  $c_i$  has only one non convex vertex, contradiction.

We conclude that all rays of  $u_i$  which enter  $V$  have to exit  $V$ . As seen in case 1 they cannot escape compact sets in  $\mathcal{O}$ . They converge to a collection of (line) leaves in  $\mathcal{O}^u$ . As in case 1, one of them, call it  $u$  makes a perfect fit with  $r$ . Since  $u, r$  make a perfect fit and  $\tilde{e}_i$  escapes compact sets, it follows that for  $i$  big  $e_i$  intersects  $u$  and the second edge of  $e_i$  is in leaves  $v_i$  of  $\mathcal{O}^s$  and  $v_i$  intersects  $u$ .

The first possibility here is that  $u$  contained in  $V$ . Let  $W$  be the component of  $\mathcal{O} - u$  contained in  $V$ . Since  $r, u$  make a perfect fit and  $\tilde{f}_i \cap \tilde{e}_i \neq \emptyset$  it follows that  $\tilde{f}_i$  has to intersect  $W$ . Since  $u \subset V$ , then  $c_i$  has to intersect  $u$  twice – this is a contradiction as seen before. The second possibility is that  $u$  is not contained in  $V$  and intersects  $\alpha$ . Notice that  $u$  is a ray equivalent to  $r$ . We can now restart the proof of case 2 with  $u, l$  instead of  $r, l$ . The arguments above will produce a leaf  $v$  of  $\mathcal{O}^s$  making a perfect fit with  $u$ . Figure 6 illustrates the impossible situation that  $v \subset V$ . In that case some  $c_j$  is forced to have 2 non convex vertices. Hence  $v$  intersects  $\alpha$ . As in case 1, one can iterate this argument to arrive at a contradiction.

This finishes the proof of lemma 3.6.  $\square$

**Remarks** – If  $A = (a_i)$  is an admissible sequence and  $B = (a_{i_j})$  is a subsequence, then clearly  $B$  is also an admissible sequence and furthermore  $A \leq B$  and  $B \leq A$ . It is also immediate from the nesting property that if  $A = (a_i), C = (c_i)$  are admissible sequences, then the condition that  $\tilde{a}_i \cap \tilde{c}_j \neq \emptyset$  for all  $i, j$  is equivalent to  $\tilde{a}_i \cap \tilde{c}_i \neq \emptyset$  for all  $i$ .

**Lemma 3.7.** *Suppose that  $\Phi$  is not topologically conjugate to a suspension Anosov flow. Then the relation  $\cong$  is an equivalence relation for admissible sequences of polygonal paths.*

*Proof.* Clearly  $\cong$  is reflexive and symmetric. Suppose now that  $A = (a_i), B = (b_i), C = (c_i)$  are admissible sequences of polygonal paths and  $A \cong B, B \cong C$ . Then there are  $D = (d_i)$  with  $A \leq D, B \leq D$  and  $E = (e_i)$  with  $B \leq E, C \leq E$ . If for some  $i, j$  the  $\tilde{d}_i$  and  $\tilde{e}_j$  do not intersect this contradicts  $B \leq D, B \leq E$ .

Claim – Let  $j$  be given. Then either there is  $i > j$  with  $\tilde{a}_i \subset \tilde{e}_j$  or there is  $i > j$  with  $\tilde{c}_i \subset \tilde{d}_j$ .

Along the proof we may replace  $j$  by a bigger number – by the nesting property the result follows for the original  $j$ . The proof is by contradiction. So assume the claim fails. For each  $i$ , then  $\tilde{a}_i \not\subset \tilde{e}_j$  and  $\tilde{c}_i \not\subset \tilde{d}_j$ . Clearly this implies that none of  $\tilde{d}_j, \tilde{e}_j$  is contained in the other. Define

$$Z' := \tilde{e}_j \cap \tilde{d}_j$$

This is an open subset of  $\mathcal{O}$ , which is non compact as there is  $m \geq j$  with  $\tilde{b}_m \subset \tilde{e}_j \cap \tilde{d}_j$ . It is conceivable that that even though  $\tilde{d}_j, \tilde{e}_j$  are convex,  $Z'$  may not be connected. In any case let  $Z$  be the component of  $Z'$  containing  $\tilde{b}_m$ . Obviously  $Z$  is non compact. Notice that  $\partial Z$  is made up of segments or rays in  $e_j$  or  $d_j$ . In addition  $\partial Z$  has at least two infinite rays because  $Z$  is non compact. It is easy to prove that  $\partial Z$  is convex for  $Z$  because of this property for  $d_j, e_j$ .

We first deal with the following situation. Suppose that  $\partial Z$  has two bi-infinite components. Then  $e_j, d_j$  do not intersect and the region between  $d_j$  and  $e_j$  is equal to  $Z$ . Let  $\alpha$  be an arc intersecting  $e_j, d_j$  only in its boundary. We can assume that  $\alpha$  does not intersect  $\tilde{b}_m$ . Since  $(\tilde{d}_k)$  escapes compact sets in  $\mathcal{O}$ , then it eventually stops intersecting  $\alpha$ , so choose  $k > j$  with  $\tilde{d}_k \cup d_k$  not intersecting  $\alpha$ . If  $e_k$  does not intersect  $d_k$ , then either  $\tilde{e}_k \subset \tilde{d}_k$  or  $\tilde{d}_k \subset \tilde{e}_k$ . This is because  $\tilde{e}_k \subset \tilde{e}_j, \tilde{d}_k \subset \tilde{d}_j, \tilde{d}_k, \tilde{e}_k$  intersect and

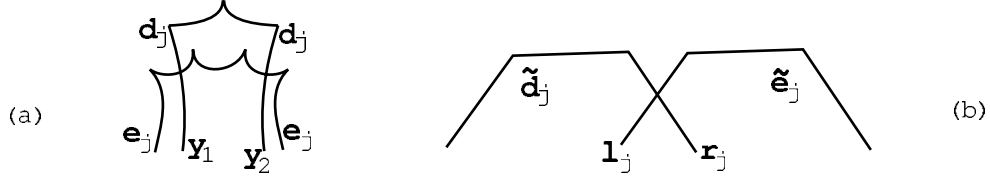

Figure 7: *a. The intersection of convex neighborhoods, b. Intersecting master sequences.*

$d_k \cup \tilde{d}_k$  does not intersect  $\alpha$ . Assume wlog that  $\tilde{e}_k \subset \tilde{d}_k$ . Choose  $i > k > j$  with  $\tilde{c}_i \subset \tilde{e}_k$  which is a subset of  $\tilde{d}_k$  and hence of  $\tilde{d}_j$ . This proves the claim in this case.

Therefore by taking a bigger  $j$  if necessary we can assume that  $Z$  has only one bi-infinite boundary component. Let  $y_1, y_2$  be the rays of  $d_j$  and  $z_1, z_2$  be the rays of  $e_j$ . The bi-infinite component of  $\partial Z$  has two rays which are contained in  $y_1 \cup y_2 \cup z_1 \cup z_2$ . If there are subrays of both rays in this boundary  $\partial Z$  which are contained in  $y_1 \cup y_2$ , then it follows that  $\tilde{d}_j \cup d_j - (\tilde{e}_j \cup e_j)$  is contained in a compact set in  $\mathcal{O}$ , see fig. 7, a. Since the decreasing sequence  $(\tilde{d}_k)_{k \in \mathbb{N}}$  of open sets in  $\mathcal{O}$  escapes compact sets in  $\mathcal{O}$ , then there would be  $k$  with  $\tilde{d}_k \subset \tilde{e}_j$ . But then there is  $i$  with  $\tilde{a}_i \subset \tilde{d}_k \subset \tilde{e}_j$  and this would yield the claim in this case.

The remaining possibility to be analysed is that one and only one boundary ray of  $\partial Z$  must be contained in  $y_1 \cup y_2$  and one and only one boundary ray of  $\partial Z$  is in  $z_1 \cup z_2$ . This last fact also implies that if a boundary ray is contained in  $y_1 \cup y_2$  then it cannot have a subray in  $z_1 \cup z_2$ . The argument here will be to produce two fixed rays  $r, l$  of  $\mathcal{O}^s$  or  $\mathcal{O}^u$  which always intersect  $\tilde{d}_i, \tilde{e}_i$  respectively and so that  $r, l$  are not equivalent. This will contradict the fundamental lemma.

Let  $l_j$  be the boundary ray of  $Z$  contained in  $z_1 \cup z_2$ . Then this ray is in  $\tilde{d}_j \cup d_j$  and since it cannot have a subray contained in  $d_j$  it follows that it has a subray contained in  $\tilde{d}_j$ . It also follows that the other ray of  $e_j$  has to be eventually disjoint from  $\bar{Z}$ . Similarly there is a ray  $r_j$  of  $d_j$  contained in  $\tilde{e}_j$ , see fig. 7, b. Recall that  $\tilde{b}_m \subset \tilde{d}_j \cap \tilde{e}_j$ . Now consider  $i \geq j$ . If  $\tilde{d}_i \subset \tilde{e}_j$  then we are done. Otherwise

$$\tilde{d}_i \cap \tilde{e}_j \neq \emptyset \quad \text{and} \quad \tilde{d}_i \not\subset \tilde{e}_j$$

so the same analysis as above produces a ray of  $e_j$  contained in  $\tilde{d}_i$ . It can only be  $l_j \cap \tilde{d}_i$  since the other ray of  $e_j$  is disjoint from  $d_j \cup \tilde{d}_j$ , so certainly disjoint from  $d_i \cup \tilde{d}_i$ . It now follows that for any  $i \geq j$  there is a subray of the fixed ray  $l_j$  which is contained in  $\tilde{d}_i$ . Similarly for any  $i \geq j$  there is a subray of the fixed  $r_j$  contained in  $\tilde{e}_i$ .

The set  $\tilde{d}_j \cap \tilde{e}_j$  has boundary which contains subrays of  $r_j, l_j$ . If  $r_j, l_j$  are equivalent rays then as there is  $i$  with  $\tilde{b}_i \subset \tilde{e}_j \cap \tilde{d}_j$ , the two rays of  $b_i$  would be equivalent, contradiction. Hence  $r_j, l_j$  are not equivalent. But for any  $i \geq j$ , then  $\tilde{d}_i \cup \tilde{e}_i$  is a union of two convex regions containing subrays of  $l_j$  and  $r_j$  ( $j$  is fixed!). This is disallowed by the fundamental lemma 3.6. This proves the claim.

Suppose then there are infinitely many  $j$ 's so that for each one of them, there is  $i(j) > j$  with  $\tilde{a}_{i(j)} \subset \tilde{e}_j$ . Then for any  $k$  there is one such  $j$  with  $j > k$  and so there is  $i(j) > j$  with  $\tilde{a}_{i(j)} \subset \tilde{e}_j \subset \tilde{e}_k$ . This means that  $A \leq E$  and so  $A \cong C$ . The claim shows that if this does not occur, then there are infinitely many  $j$  and for each such  $j$  there is  $i(j) \geq j$  and  $\tilde{c}_{i(j)} \subset \tilde{d}_j$ . This now implies that  $C \leq D$  and again  $C \cong A$ . This finishes the proof that  $\cong$  is an equivalence relation.  $\square$

We first analyse admissible sequences associated to rays of  $\mathcal{O}^s$  or  $\mathcal{O}^u$  – each ray will define an ideal point of  $\mathcal{O}$ . Later we define general points of  $\mathcal{O}$ . We will be interested in the asymptotic behavior as points escape the ray to infinity. A ray does not separate  $\mathcal{O}$ , but still one can define sides of a ray as follows: let  $l$  be a ray of (say)  $\mathcal{O}^s$ . Fix a regular point  $p$  in  $l$  and consider the component  $W$  of  $\mathcal{O} - \mathcal{O}^u(p)$  which contains a subray of  $l$ . Then  $l \cap V$  separates  $V$  and we can talk about the sides of  $l$  in  $V$ . This depends only on the ray  $l$  and not on the point  $p$ .

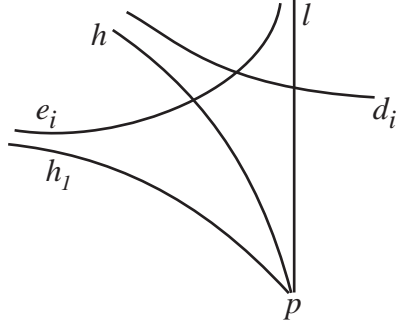

Figure 8: The process of creating standard sequences for rays of  $\mathcal{O}^s, \mathcal{O}^u$ . Here the sequence  $(d_i)$  of  $\mathcal{O}^u$  does not escape compact sets and limits to  $h$  leaf of  $\mathcal{O}^u$  making a perfect fit with  $l$ . There is also the sequence  $(e_i)$  of leaves of  $\mathcal{O}^s$  whose intersection with  $h$  escapes in  $h$  and  $(e_i)$  limits to a leaf  $h_1$  of  $\mathcal{O}^s$  making a perfect fit with  $h$ . The leaves  $l, h_1$  are not separated from each other in the leaf space of  $\mathcal{O}^s$ .

**Definition 3.8.** (standard sequences) Let  $l$  be a ray in  $\mathcal{O}^s$  or  $\mathcal{O}^u$ . For simplicity assume that it is in  $\mathcal{O}^s$ . Fix a side of  $l$ . Let  $d_i$  be a nested sequence of leaves of  $\mathcal{O}^u$  intersecting  $l$  with  $d_i \cap l$  escaping  $l$ . If  $d_i$  escapes compact sets in  $\mathcal{O}$  then  $(d_i)$  is an admissible sequence which is called a standard sequence associated to  $l$ . If the  $d_i$  do not escape in  $\mathcal{O}$ , then they limit on a collection of unstable leaves. There is one of them, call it  $h$  which makes a perfect fit with  $l$  on the fixed side of  $l$ . Consider now  $e_i$  stable (nonsingular) leaves intersecting  $h$  and so that  $h \cap e_i$  escapes compact sets in  $h$  and moves in the direction toward the perfect fit with  $l$ . Since  $l$  and  $h$  form a perfect fit, then for big enough  $i$ , the  $e_i$  and  $d_i$  intersect and form a polygonal path of length 2, see fig. 8.

We want to produce an escaping polygonal sequence in that side of  $l$  and we already achieved that with  $d_i \cup e_i$  for the region between  $l$  and  $h$ . Therefore we want to analyse what happens beyond  $h$ , that is, the side of  $h$  opposite to  $l$  or not containing  $l$ . If the rays of  $e_i - h$  in the side of  $h$  opposite to  $l$  escape in  $\mathcal{O}$  then the polygonal paths made up of a segment of  $d_i$  and a ray of  $e_i$  escape compact sets in  $\mathcal{O}$ . Otherwise the rays of  $e_i - h$  on that side of  $h$  limit to a stable leaf  $h_1$  making a perfect fit with  $h$ , see fig. 8. Notice that  $h_1$  and  $l$  are not separated from each other in the leaf space of  $\mathcal{O}^s$  – because the sequence  $(e_i)$  converges to both of these leaves. Now iterate this process. If this stops after finitely many steps then take a sequence of polygonal paths of fixed length. Otherwise there are infinitely many leaves  $h_j, j \geq 2$ , alternatively in  $\mathcal{O}^s, \mathcal{O}^u$ , so that appropriate rays of  $h_j$  make a perfect fit with  $h_{j-1}$  and  $h_{j+1}$ . In this case use polygonal paths of increasing lengths, in order to cross over an increasing number of perfect fits emanating from  $l$ , see fig. 9. Do the same for the other side of  $l$ . The ensuing sequence  $(a_i)$  is an admissible sequence associated to the ray  $l$ . It is called a standard sequence for the ray  $l$  of  $\mathcal{O}^s$  or  $\mathcal{O}^u$ .

**Remark** – If there are no perfect fits then  $(d_i)$  as in definition 3.8 is a standard sequence for the ray  $l$ .

There are several other important remarks here and they concern only the case with perfect fits. Along the way we will introduce the concepts of infinite perfect fits and perfect fit horoballs. First notice that standard sequences for a given ray  $l$  are not unique. By construction it is easy to see that the  $a_i$  are convex, the rays of each  $a_i$  are not equivalent to each other and the sequence  $(a_i)$  is nested. To check whether  $\tilde{a}_i$  is escaping: If the  $a_i$  have fixed length with  $i$  then it is easy to see this. Otherwise notice that the collection of rays equivalent to a given ray escapes compact sets in  $\mathcal{O}$ , in fact the whole leaves do. That is, if  $h_1, h_2, h_3, h_4 \dots$  are the leaves produced by the construction in the definition, then  $h_j, h_{j+2}$  are not separated from each other in the respective leaf space. Then the sequence  $(h_i)$  escapes compact sets in  $\mathcal{O}$ . So the sequence  $(a_i)$  again escapes compact sets. Hence  $(a_i)$  is admissible. In addition  $h_i$  separates  $h_k$  from  $h_j$  for any  $k < i < j$ .

### Infinite perfect fits and perfect fit horoballs

In the case that the process above does not stop we call the infinite collection of perfect fits an

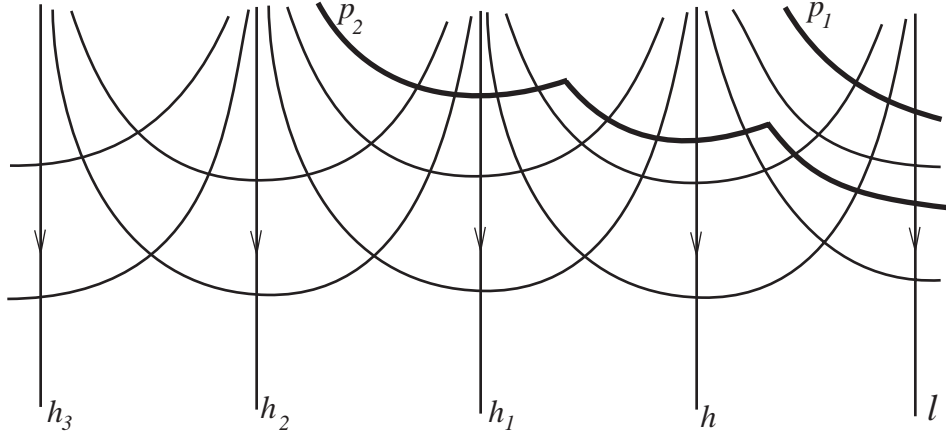

Figure 9: *A picture of an infinite perfect fit or a perfect fit horoball. Here  $l, h_1, h_3$  are rays of  $\mathcal{O}^s$  and  $h, h_2$  are rays of  $\mathcal{O}^u$ . The arrows indicate the direction of the rays.  $l$  and  $h_1$  are not separated from each other in the leaf space of  $\mathcal{O}^s$  and similarly for  $h_1, h_3$  and also for  $h, h_2$  (leaf space of  $\mathcal{O}^u$  for the last 2). The figure is intended to continue indefinitely in both horizontal directions. The bold paths  $p_1, p_2$  are 2 steps in producing a standard sequence for the ray  $l$ .  $p_1$  is a polygonal path of length 1 and  $p_3$  is a polygonal path of length 3 (we are only describing what happens in one side of  $l$ ).*

*infinite perfect fit.* Associated to this one can define a model for a *perfect fit horoball* in  $\mathcal{O}$  as follows: take the punctured square  $[-1, 1] \times [-1, 1] - \{0, 0\}$  with its horizontal and vertical foliations and lift it to its universal cover  $U$ . A proper, foliation respecting (horizontal goes to stable, vertical goes to unstable) embedding of  $U$  into  $\mathcal{O}$  gives an intuitive “neighborhood” of an ideal point associated to an infinite perfect fit as above. Such points clearly seem to have a “parabolic” feel as one suspects there is a covering translation which preserves the perfect fit horoball and acts as a translation in the collection of the perfect fits. This is in analogy with Kleinian groups.

Two important questions arise: Is this possible for pseudo-Anosov flows? Also is there a non trivial isotropy group of this infinite perfect fit structure and why does it not contradict that the action of  $\pi_1(M)$  is cocompact? First of all this phenomenon does happen, in fact there are several examples, even for Anosov flows. The first one is the seminal example of Franks and Williams [Fr-Wi] of an intransitive Anosov flow in a closed 3-manifold. There is a simple picture of an infinite perfect fit in the figure in page 164 of [Fr-Wi]. A second, also famous example, is that of the Bonatti-Langevin [Bo-La] example of a transitive Anosov flow with a transverse torus and not conjugate to a suspension. The structure in the universal cover of this example is briefly described in [Fe4].

Once existence of infinite perfect fits is established, one wants to understand its structure. Notice that infinite perfect fits have in particular infinitely many pairs of leaves non separated from each other. The author previously proved [Fe4, Fe5] that up to covering translations there are only finitely leaves of  $\mathcal{O}^s$  or  $\mathcal{O}^u$  which are not separated from another leaf in the respective leaf space. Hence given the collection  $(h_j)$  produced above so that  $h_j$  forms a perfect fit with  $h_{j+1}$ , there are  $j \neq k$  and  $g$  in  $\pi_1(M)$  so that  $g(h_j) = h_k$ . This implies that the infinite sequence of perfect fits is in fact a bi-infinite sequence – that is, it extends indefinitely in the other direction as well. It also justifies the terminology parabolic used above. In addition if  $z$  in  $\mathcal{O}^s$ ,  $\mathcal{O}^u$  is non separated from another leaf, then the isotropy group of  $z$  is non trivial [Fe4, Fe5]. In particular this is true of every  $h_j$ . With a little more work this implies that associated to an infinite perfect fit there is a  $\mathbf{Z}^2 \oplus \mathbf{Z}^2$  subgroup of  $\pi_1(M)$  which leaves the whole structure invariant. Hence if  $M$  is atoroidal, there can be no infinite sequence of perfect fits.

Finally, given the association of parabolic behavior with non compact manifolds, how does this interact with the fact that  $M$  is compact? In the case of a hyperbolic 3-manifold and a  $\mathbf{Z} \oplus \mathbf{Z}$  cusp, then geodesics escaping to the cusp are asymptotic. In the case of pseudo-Anosov flows, suppose that leaves  $l, h$  of  $\mathcal{O}^s$

and  $\mathcal{O}^u$  make a perfect fit. We need to analyse the situation in  $\widetilde{M}$ , not  $\mathcal{O}$ . Let then (say)  $L$  in  $\widetilde{\Lambda}^s$  which projects to  $l$  in  $\mathcal{O}$  and similarly  $H$  in  $\widetilde{\Lambda}^u$  projecting to  $h$ . Then  $L, H$  make a perfect fit. But they are not asymptotic as points escape in  $L$  or  $H$ . If they were, then in fact  $L$  and  $H$  would intersect because of the local product structure of  $\Lambda^s, \Lambda^u$ . In particular  $L, H$  would not form a perfect fit. At this point it is useful to stress once more that the orbit space  $\mathcal{O}$  is a topological and dynamical object, but it is not a metric object. Even though topologically it may seem that rays of  $\mathcal{O}^s, \mathcal{O}^u$  making a perfect fit are getting close, this can only be checked in  $\widetilde{M}$ , where in fact one sees that their lifts are not getting close.

**Lemma 3.9.** *Let  $l$  be a ray in  $\mathcal{O}^s$  or  $\mathcal{O}^u$  and let  $C = (c_i)$  be a standard sequence associated to  $l$ . Let  $A = (a_i)$  be an admissible sequence so that for any  $i$ , then  $\widetilde{a}_i \cup a_i$  contains a ray equivalent to  $l$ . Then  $A \leq C$ .*

*Proof.* Suppose the lemma is not true and fix an  $i$  so that for any  $j$ ,  $\widetilde{a}_j \not\subset \widetilde{c}_i$ . Notice first that by the definition of a standard sequence, then for any  $m$  (in particular for  $m = i$ ) and for any ray  $s$  equivalent to  $l$ , then  $s$  has a subray  $s'$  contained in  $\widetilde{c}_m$ . Since for any  $j$ ,  $\widetilde{a}_j \cap a_j$  contains such a ray  $s$  then  $\widetilde{a}_j \cap \widetilde{c}_i \neq \emptyset$ . If in addition  $\widetilde{a}_j \not\subset \widetilde{c}_i$ , then as seen in the fundamental lemma, for  $j$  big enough, there is at least one ray of  $c_i$  which has a subray contained in  $\widetilde{a}_j$ . By the fundamental lemma, after discarding finitely many terms in  $(a_j)$  there is a fixed ray  $r$  of  $(c_i)$  which for every  $j$  has a subray contained in  $\widetilde{a}_j$ . Notice that  $r$  and  $l$  are not equivalent. We conclude that every  $\widetilde{c}_j$  contains a subray of the fixed ray  $l$  and every  $\widetilde{a}_j$  contains a subray of the fixed ray  $r$ . Since for any  $j, m$ ,  $\widetilde{c}_j \cap \widetilde{a}_m \neq \emptyset$  this is disallowed by the fundamental lemma. This finishes the proof of the lemma.  $\square$

We now define ideal points of  $\mathcal{O}$ .

**Definition 3.10.** *Suppose that  $\Phi$  is not topologically conjugate to a suspension Anosov flow. A point in  $\partial\mathcal{O}$  or an ideal point of  $\mathcal{O}$  is an equivalence class of admissible sequences of polygonal paths. Let  $\mathcal{D} = \mathcal{O} \cup \partial\mathcal{O}$ .*

Given  $R$ , an admissible sequence of polygonal paths, let  $\overline{R}$  be its equivalence class under  $\cong$ . Notice that each ray  $l$  in  $\mathcal{O}^s, \mathcal{O}^u$  has admissible sequences and these sequences are all equivalent. In this way  $l$  defines a single point in  $\partial\mathcal{O}$  which is denoted by  $\partial l$ . This is generalized in the following way: if  $l$  is a leaf of  $\mathcal{O}^s$  or  $\mathcal{O}^u$ , then we denote by  $\partial l$  the collection of ideal points of rays of  $l$ . If  $l$  is a ray of  $\mathcal{O}^s, \mathcal{O}^u$  associated to infinite perfect fit then  $\partial l$  is called a parabolic ideal point in  $\partial\mathcal{O}$ . We will see later that in this case  $\partial l$  is the unique fixed point of the action of some  $g$  in  $\pi_1(M)$  which acts in a “parabolic” way on  $\partial\mathcal{O}$ .

**Definition 3.11.** *(master sequences) Let  $R$  be an admissible sequence. An admissible sequence  $C$  defining  $\overline{R}$  is a master sequence for  $\overline{R}$  if for any  $B \cong R$ , then  $B \leq C$ .*

Why master sequences? Ideal points are defined by admissible sequences of polygonal paths and not by sequences of points in  $\mathcal{O}$ . Given the admissible sequence  $(a_i)$  defining an ideal point  $p$ , one intuitively expects that a fixed  $\widetilde{a}_i$  will at least limit on all points of  $\partial\mathcal{O}$  near  $p$  (the topology in  $\mathcal{O} \cup \partial\mathcal{O}$  will be defined formally later). However this is not the case. For example given  $l$  a ray in  $\mathcal{O}^s$  with no perfect fits associated to it, consider a sequence of regular leaves  $d_i$  in  $\mathcal{O}^u$  with  $d_i \cap l$  escaping in  $l$ . Then  $(d_i)$  defines the ideal point  $\partial l$ . Now fix a side of  $l$  and consider the rays of  $d_i - l$  in this side of  $l$ . For each  $i$ , this ray, together with an appropriate subray of  $l$  forms a convex polygonal path  $b_i$  and defines an admissible sequence  $(b_i)$ . Intuitively  $\widetilde{b}_i$  is  $\widetilde{d}_i$  cut in half by a ray of  $l$ . Clearly  $(d_i)$  and  $(b_i)$  are equivalent, so  $(b_i)$  also defines the same ideal point. But a fixed  $\widetilde{b}_i$  only accumulates on one side of  $l$ . The master sequences are those  $(d_i)$  for which an individual  $\widetilde{d}_i$  “limits on both sides” of the ideal point.

**Remark** – Recall that a *cyclic order* on a set  $B$  is a partition of the set of pairwise distinct triples  $(p, q, r)$  into two sets, called the “positive and negative triples”, such that cyclic permutations in  $(p, q, r)$  preserve the sign, non cyclic permutations reverse the sign and if  $(p, q, r)$  and  $(r, s, p)$  are positive triples, then  $(q, r, s)$  is also a positive triple.

**Definition 3.12.** (*order of sets in  $\mathcal{O}$* ) Let  $\mathcal{C} = \{c_i\}, i \in I \subset \mathbf{Z}$  be a collection of properly embedded bi-infinite arcs in  $\mathcal{O}$  so that there are components  $\tilde{c}_i$  of  $\mathcal{O} - c_i$  with  $\{c_i \cup \tilde{c}_i\}$  pairwise disjoint. Suppose that  $\mathcal{C}$  is locally finite: any compact set in  $\mathcal{O}$  intersects only finitely many of the  $c_i$ . Fix  $x \in \mathcal{O}$  not in any  $c_i \cup d_i$  and choose paths  $\gamma_i$  from  $x$  to  $c_i$  which are pairwise disjoint except for  $x$ . This is all possible since  $\mathcal{O} \cong \mathbf{R}^2$ . Then the germs of the collection  $\{\gamma_i\}$  at  $x$  put a cyclic order in the collection  $\{\gamma_i\}$  and hence on  $\mathcal{C}$ . This order is independent of  $x$  or the paths  $\gamma_i$ . If all  $\tilde{c}_i$  miss a fixed properly embedded infinite arc  $\gamma$  starting at  $x$ , then there is a linear order in  $\mathcal{C}$ . The linear order depends on the path  $\gamma$ .

**Lemma 3.13.** *Given an admissible sequence  $R$ , there is a master sequence for  $\overline{R}$ .*

*Proof. Case 1* – Suppose that for any  $A = (a_i), B = (b_i)$  in  $\overline{R}$  and for any  $i, j$  then  $\tilde{a}_i \cap \tilde{b}_j \neq \emptyset$ .

We claim that in this case any  $A \cong R$  will serve as a master sequence. That is we do not have the situation described above were one slices through the admissible regions using a fixed ray of  $\mathcal{O}^s$  or  $\mathcal{O}^u$ . Choose  $A \cong R$  and let  $B \cong R$ . We want to show that  $B \leq A$ . So by way of contradiction,

$$\text{assume that there is } i \text{ so that for any } j, \tilde{b}_j \not\subset \tilde{a}_i \quad (*)$$

This also works for any  $k \geq i$ , but we will fix  $i$  from now on in case 1. The contradiction will be obtained by first showing that  $(*)$  implies that  $A$  is associated to an ideal point of a ray of  $\mathcal{O}^s$  or  $\mathcal{O}^u$  and then producing two admissible sequences in  $\overline{R}$  which fail the hypothesis of case 1.

In case 1,  $\tilde{b}_j \cap \tilde{a}_i$  is not empty for any  $j$ . Let  $u, v$  be the rays of  $a_i$ . Since  $\tilde{b}_j$  escapes compact sets in  $\mathcal{O}$  as  $j \rightarrow \infty$ , so does  $\tilde{b}_j \cap \tilde{a}_i$ . The arguments of lemma 3.7, referring to figure 7, a; show that  $\tilde{a}_i \cup a_i$  cannot contain subrays of both rays in  $b_j$  and in fact for  $j$  big enough, then  $\tilde{b}_j$  contains at least one subray  $u$  or  $v$  and no singular point. This implies that  $a_i$  cuts  $\tilde{b}_j$  into at most 3 non compact regions (all of which are convex): at most one region contained in  $\tilde{a}_i$  and at least one and at most 2 disjoint from  $\tilde{a}_i$ . The regions are convex because one can assume  $j$  is big enough so that the  $b_j \cap a_i$  does not contain any singularity. Up to discarding finitely many terms we may assume that one region contains in its boundary a subray of (say)  $u$ . Call this region  $\tilde{c}_j$  with boundary  $c_j$ .

There are 2 possibilities: i) For  $j$  big enough, the region  $\tilde{c}_j$  disappears, that is, there is no such region with a subray  $u$  in the boundary. In that case there is another region  $\tilde{d}_j$  of  $\tilde{b}_j$  cut along  $a_i$  disjoint from  $\tilde{a}_i$  and containing a subray of  $v$  in the boundary. If  $\tilde{d}_j$  also eventually disappears, then some  $\tilde{b}_k$  is contained in  $\tilde{a}_i$ , contrary to assumption in this argument. So at least one of  $(\tilde{c}_j), (\tilde{d}_j)$  is always non empty. This reduces to the following: ii) (say)  $\tilde{c}_j$  is never empty for any  $j$ . Then  $b_j$  contains a subray of  $u$  for any  $j$ . Let  $E = (e_k)$  be a standard sequence associated with the ray  $u$ . Eliminating finitely many initial terms of  $E$  if necessary we can assume that  $u$  cuts every  $\tilde{e}_k$  into two components  $f_k$  and  $\tilde{g}_k$ , which are convex, with boundaries  $f_k$  and  $g_k$  respectively and defining admissible sequences  $F = (f_k)$  and  $G = (g_k)$ . Assume that  $f_k \cap \tilde{a}_i = \emptyset$  for all  $k$ . Clearly  $F \leq E, G \leq E$  and  $f_k \cap \tilde{g}_k = \emptyset$ .

Suppose that for some  $m > i$ ,  $a_m$  does not have a ray equivalent to  $u$ . Fix this  $m$ . Notice that  $\tilde{b}_j$  contains a subray of a fixed ray of  $a_m$  and also a fixed subray of  $u$  (this is a ray of  $a_i$  with  $i$  fixed). This is now disallowed by the fundamental lemma.

The remaining possibility in this case is that  $a_m$  always has a ray equivalent to  $u$  for any  $m$ . By lemma 3.9 it follows that  $A \leq E$  and so  $R \cong A \cong E \cong F \cong G$ . Hence in  $\overline{R}$  there are  $F = (f_k), G = (g_k)$  with  $f_k \cap \tilde{g}_k = \emptyset$  for some  $k$ . This contradicts the hypothesis in case 1 and implies that  $A$  is a master sequence for  $\overline{R}$ .

Case 2 – There are  $A, B$  in  $\overline{R}$  and  $i$  so that  $\tilde{a}_i, \tilde{b}_i$  are disjoint.

Fix this  $i$ . In particular  $\tilde{a}_k, \tilde{b}_k$  are disjoint for  $k \geq i$ . Let  $C$  be an admissible sequence with  $A \leq C, B \leq C$ . We claim that  $C$  is a master sequence for the class  $\overline{R}$ . Let  $D \cong A$ . Suppose that  $D \not\leq C$ . Hence there is  $m$  so that  $\tilde{d}_j \not\subset \tilde{c}_m$  for any  $j$ . Fix this  $m$ . There are two options: i) There is  $k$  with  $\tilde{d}_k \cap \tilde{c}_k = \emptyset$ , or ii) For any  $k, \tilde{d}_k \cap \tilde{c}_k \neq \emptyset$ , in which case  $\tilde{d}_k \cap \tilde{c}_j \neq \emptyset$  for any  $k, j$ .

In subclass i) up to deleting a few initial terms we may assume that  $\tilde{d}_1 \cap \tilde{c}_1 = \emptyset$ . We have  $A \cong B \cong D$  with  $\tilde{a}_i, \tilde{b}_i, \tilde{d}_i$  disjoint. Choose  $E = (e_j)$  with  $C \leq E, D \leq E$ . Assume for simplicity that  $i$  is big enough



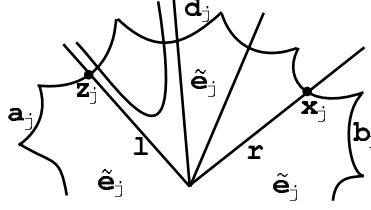

Figure 10: *Interpolating chains that intersect to produce a new convex chain.*

so that  $\tilde{a}_i, \tilde{b}_i, \tilde{d}_i$  are contained in  $\tilde{e}_1$ . This puts a linear order in  $a_i, b_i, d_i$  and we can assume without loss of generality that  $b_i$  is between  $a_i$  and  $d_i$ . Since  $b_i$  is between  $a_i$  and  $d_i$  then: for any  $j$ ,  $\tilde{e}_j$  contains subrays of the rays of  $b_i$  (with  $i$  fixed!), which are not equivalent. The fundamental lemma 3.6 implies this is impossible.

We now consider option ii). Since  $\tilde{a}_i \cup a_i$  and  $\tilde{b}_i \cup b_i$  are disjoint and  $A \leq C, B \leq C$ , then there is a ray  $u$  of  $a_i$  and a ray  $v$  of  $b_i$  so that for any  $j$ ,  $\tilde{c}_j$  contains subrays of  $u$  and  $v$ . A priori  $u, v$  can be equivalent. Since  $\tilde{d}_j$  is not contained in  $\tilde{c}_m$  but has to intersect  $\tilde{c}_m$ , we may assume up to eliminating a few initial terms that  $\tilde{d}_j$  always contains a subray of a fixed ray  $y$  of  $c_m$ . The rays  $y, u$  are not equivalent. Since  $\tilde{d}_j \cap \tilde{c}_k \neq \emptyset$  for any  $k, j$ , this contradicts the fundamental lemma. So this cannot happen either.

We conclude that  $C$  is a master sequence for  $\overline{R}$ . This finishes the proof of lemma 3.13.  $\square$

By definition for any 2 master sequences  $A, B$  in the class  $\overline{R}$ , it follows that both  $A \leq B$  and  $B \leq A$  hold.

**Lemma 3.14.** *Let  $p, q$  in  $\partial\mathcal{O}$ . Then  $p, q$  are distinct if and only if there are master sequences  $A = (a_i), B = (b_i)$  associated to  $p, q$  respectively with  $(a_i \cup \tilde{a}_i) \cap (b_j \cup \tilde{b}_j) = \emptyset$  for some  $i, j$ .*

*Proof.* We first show that  $p, q$  are distinct if and only if there are master sequences  $A = (a_i), B = (b_i)$ , so that for some  $i, j$ ,  $\tilde{a}_i \cap \tilde{b}_j = \emptyset$ . In the proof we show that the negations are equivalent. First suppose that  $p = q$ . Let  $A, B$  be any master sequences associated to  $p = q$ . Then since  $A, B$  are master sequences associated to the same equivalence class then  $A \leq B$  and  $B \leq A$ . Therefore we can never have  $\tilde{a}_i \cap \tilde{b}_j = \emptyset$ . This is the easy implication.

To prove the converse, suppose that for any master sequences  $A = (a_i)$  and  $B = (b_i)$  associated to  $p, q$  respectively and any  $i, j$  then  $\tilde{a}_i \cap \tilde{b}_j \neq \emptyset$ . Let  $A, B$  be such a pair. Suppose first that for all  $i$ ,  $\tilde{a}_i \cap \tilde{b}_i$  has 2 non compact components. Then an argument similar to one in the proof of lemma 3.13 shows that there are non equivalent rays  $u, v$  with subrays contained in each  $\tilde{a}_i \cap \tilde{b}_i$ . This is disallowed by the fundamental lemma. Similarly if  $\tilde{a}_i \cap \tilde{b}_i$  has a component with 4 boundary rays for infinitely many  $i$ . On the other hand,  $\tilde{b}_i \cap \tilde{a}_j$  can never be contained in a compact set or else for some  $i' > i$  then  $\tilde{a}_j \cap \tilde{b}_{i'} = \emptyset$ . One concludes that  $\tilde{a}_i \cap \tilde{b}_i$  eventually has a single non compact component. Let  $\tilde{c}_i$  be this component of  $\tilde{a}_i \cap \tilde{b}_i$  and let  $c_i = \partial\tilde{c}_i$ . Let  $C = (c_i)$ . Clearly  $c_i$  is convex and  $(c_i)$  is nested. But a priori,  $C$  may not be admissible, that is, the boundary rays may be equivalent. Notice that the rays in  $c_i$  are subrays of rays of  $a_i$  or  $b_i$ .

The first case is that the rays of  $c_i$  are not equivalent for any  $i$ . Then  $c_i$  is a convex polygonal path, non empty and  $C$  is an admissible sequence. Also  $C \leq A, C \leq B$ , which implies that  $A \cong C \cong B$  and hence  $p = q$ .

The second case is that there is  $i$  so that the rays  $u, v$  of  $c_i$  are equivalent. Notice this can only happen if there are perfect fits. There is a collection  $\mathcal{Y} = \{u_0 = u, u_1, \dots, u_n = v\}$  of rays of  $\mathcal{O}^u, \mathcal{O}^s$  so that  $u_k, u_{k+1}$  make a perfect fit for every  $k$ . Since the sequence  $(\tilde{c}_j)$  is nested with  $j$ , the rays of  $c_j$  for  $j > j_0$  have to be in the collection  $\mathcal{Y}$ . Up to subsequence we can assume they are all subrays of fixed rays  $r, l$ . Notice that  $r \neq l$ , or else  $\tilde{b}_j \cap \tilde{a}_j = \emptyset$  for some  $j > i$ . Since  $r, l$  are equivalent they cannot both be rays of  $a_j$  (or both of  $b_j$  either). Hence up to renaming objects,  $a_j$  has a subray in  $r$  and  $b_j$  has a subray in  $l$ , for all  $j > i$ , see fig. 10.

Let  $z_j = a_j \cap l$ ,  $x_j = r \cap b_j$ . As in the proof of the fundamental lemma notice that  $\tilde{b}_j$  contains a subray of  $r$  and  $\tilde{a}_j$  contains a subray of  $l$ . Then  $z_j$  escapes in  $l$  and  $x_j$  escapes in  $r$ . Let  $a'_j$  be the component of  $a_j - z_j$  not containing a subray of  $r$  and  $b'_j$  the component of  $b_j - x_j$  not containing a subray of  $l$ . The above implies that we can connect  $z_j, x_j$  by a finite convex polygonal path  $d_j$  which extends  $a'_j \cup b'_j$  to a convex polygonal path  $e_j$ . see fig. 10. This is because  $l, r$  are connected by finitely many perfect fits. If  $z_j, x_j$  are very deep in the rays  $l, r$  then we can always connect  $z_j$  and  $x_j$  by a convex polygonal path. Notice that  $a_j$  has a subray of  $r$  so it goes to  $r$ , but  $a_j$  may reach  $r$  in a point different than  $x_j$ . If we just connect this to  $x_j$  and then follow along  $b_j$  this will produce a non convex switch in  $r$ . That is why we use the interpolating polygonal path  $d_j$ . Then the polygonal paths  $e_j$  are convex and one can construct the interpolating polygonal path  $d_j$  so that  $e_j$  escapes compact sets as  $j \rightarrow \infty$ . Then  $E = (e_j)$  defines an admissible sequence of chains. Clearly  $A \leq E$  and  $B \leq E$  so that  $A \cong B$  and again  $p = q$ .

This finishes the equivalence with the intersection condition on open sets. Finally suppose that  $\tilde{a}_i \cap \tilde{b}_i = \emptyset$  for all sufficiently big  $i$ , but  $(a_i \cup \tilde{a}_i) \cap (b_i \cup \tilde{b}_i) \neq \emptyset$  for any  $i$ . This can only happen if there is a ray  $l$  of  $\mathcal{O}^s$  or  $\mathcal{O}^u$  so that both  $a_i$  and  $b_i$  have a subray of  $l$ . Let  $C = (c_i)$  be a standard sequence for  $l$ . By lemma 3.9  $A \leq C$  and  $B \leq C$ , so  $A \cong B$  and  $p = q$ . This proves the lemma.  $\square$

We now define the topology in  $\mathcal{D} = \mathcal{O} \cup \partial\mathcal{O}$ .

**Definition 3.15.** (topology in  $\mathcal{D} = \mathcal{O} \cup \partial\mathcal{O}$ ) Let  $\mathcal{T}$  be the set of subsets  $U$  of  $\mathcal{D} = \mathcal{O} \cup \partial\mathcal{O}$  satisfying the following two conditions:

(a)  $U \cap \mathcal{O}$  is open in  $\mathcal{O}$ .

(b) If  $p$  is in  $U \cap \partial\mathcal{O}$  and  $A = (a_i)$  is any master sequence associated to  $p$ , then there is  $i_0$  satisfying two conditions: (1)  $\tilde{a}_{i_0} \subset U \cap \mathcal{O}$  and (2) For any  $z$  in  $\partial\mathcal{O}$ , if it admits a master sequence  $B = (b_i)$  so that for some  $j_0$ , one has  $\tilde{b}_{j_0} \subset \tilde{a}_{i_0}$  then  $z$  is in  $U$ .

First notice that if the second requirement works for a master sequence  $A = (a_i)$  with index  $i_0$ , then for any other master sequence  $C = (c_k)$  defining  $p$ , we can choose  $k_0$  with  $\tilde{c}_{k_0} \subset \tilde{a}_{i_0}$ . Then  $\tilde{c}_{k_0} \subset U$ . A point  $q$  of  $\partial\mathcal{O}$  which has a master sequence  $B = (b_j)$  and  $j_0$  so that

$$\tilde{b}_{j_0} \subset \tilde{c}_{k_0}; \quad \text{then} \quad \tilde{b}_{j_0} \subset \tilde{a}_{i_0}$$

so  $q$  is in  $U$ . Therefore (b) works for  $C$  instead of  $A$  with  $k_0$  instead of  $i_0$ . So we only need to check the requirements for a single master sequence.

**Lemma 3.16.**  $\mathcal{T}$  is a topology in  $\mathcal{D} = \mathcal{O} \cup \partial\mathcal{O}$ .

*Proof.* Clearly  $\mathcal{D}, \emptyset$  are in  $\mathcal{T}$ . Unions: If  $\{V_\alpha | \alpha \in \mathcal{A}\}$  is a family of sets in  $\mathcal{T}$ , then let  $V$  be their union. If  $x$  is in  $V$  and  $x$  is in  $\mathcal{O}$ , there is open set  $O$  in  $\mathcal{O}$  with  $x \in O \subset V_\alpha \subset V$  for some index  $\alpha$ , hence satisfying condition (a). Let now  $p$  in  $V \cap \partial\mathcal{O}$ . There is  $\beta \in \mathcal{A}$  with  $p \in V_\beta$ . Let  $A = (a_i)$  be a master sequence associated to  $p$ . There is  $i_0$  with

$$\tilde{a}_{i_0} \subset V_\beta \cap \mathcal{O} \subset V \cap \mathcal{O} \subset \mathcal{O}.$$

In addition if  $q \in \partial\mathcal{O}$  and  $q$  has a master sequence  $B = \{b_j\}$  and  $j_0$  with  $\tilde{b}_{j_0} \subset \tilde{a}_{i_0}$  then  $q$  is in  $V_\beta \subset V$ . Hence this  $i_0$  works for  $V$  as well. This proves that  $V$  is in  $\mathcal{T}$ .

Intersections: Let  $V_1, V_2$  be in  $\mathcal{T}$  and  $V = V_1 \cap V_2$ . Clearly  $V_1 \cap V_2 \cap \mathcal{O}$  is open in  $\mathcal{O}$ . Let  $u \in V_1 \cap V_2 \cap \partial\mathcal{O}$ . Given a master sequence  $A = (a_i)$  associated to  $u$  there is  $i_1$  with  $\tilde{a}_{i_1} \subset V_1$  and if  $q$  has master sequence  $B = (b_j)$  with  $\tilde{b}_{j_0} \subset \tilde{a}_{i_1}$  then  $q$  is in  $V_1$ . Similarly considering  $u \in V_2$ , there is index  $i_2$  satisfying the conditions for  $V_2$ . Let  $i_0 = \max(i_1, i_2)$ . Then  $\tilde{a}_{i_0}$  is contained in  $V_1$  and  $V_2$  (since  $\tilde{a}_i$  are nested). If now  $q$  is in  $\partial\mathcal{O}$  has a master sequence  $B = (b_j)$  with  $\tilde{b}_{j_0} \subset \tilde{a}_{i_0}$  for some  $j_0$  then  $q$  is in  $V_1$  and is in  $V_2$  by choice of  $i_1, i_2$ . Therefore  $q$  is in  $V$ . Hence  $V$  is in  $\mathcal{T}$ . This shows  $\mathcal{T}$  is a topology in  $\mathcal{O} \cup \partial\mathcal{O}$ .  $\square$

**Action of  $\pi_1(M)$  on  $\mathcal{D} = \mathcal{O} \cup \partial\mathcal{O}$** 

One key remark is that the action of  $\pi_1(M)$  on  $\mathcal{O}$  preserves the foliations  $\mathcal{O}^s, \mathcal{O}^u$  and sends convex polygonal paths to convex polygonal paths. It follows that  $\pi_1(M)$  acts by homeomorphisms on  $\mathcal{D}$ .

**Lemma 3.17.** *Suppose  $\pi_1(M)$  preserves orientation in  $\mathcal{O}$ . Then  $\partial\mathcal{O}$  has a natural cyclic order.*

*Proof.* Let  $p, q, r$  in  $\partial\mathcal{O}$  pairwise distinct points. By lemma 3.14, there are master sequences  $A = (a_i), B = (b_i), C = (c_i)$  associated to  $p, q, r$  respectively with  $a_1 \cup \tilde{a}_1, b_1 \cup \tilde{b}_1, c_1 \cup \tilde{c}_1$  pairwise disjoint. By definition 3.12 there is a cyclic order on  $a_1, b_1, c_1$ . This defines a cyclic order on  $p, q, r$ . This is independent of the choice of master sequences (since they are all equivalent). This order is also invariant under the action of  $\pi_1(M)$  on  $\mathcal{O}$ , since  $\pi_1(M)$  preserves orientation in  $\mathcal{O}$ . This defines a natural cyclic order in  $\partial\mathcal{O}$ .  $\square$

In general let  $\mathcal{E}$  be the index 2 subgroup of  $\pi_1(M)$  preserving orientation of  $\mathcal{O}$ . Then  $\mathcal{E}$  preserves a cyclic order in  $\partial\mathcal{O}$  and the elements in  $\pi_1(M) - \mathcal{E}$  reverse this cyclic order.

In any case pick one orientation in  $\mathcal{O}$  that defines a cyclic order in  $\partial\mathcal{O}$  (invariant only under  $\mathcal{E}$ ).

**Definition 3.18.** *(the set  $U_c$ ) For any convex polygonal path  $c$  there is an associated open set  $U_c$  of  $\mathcal{D}$ : let  $\tilde{c}$  be the corresponding convex set of  $\mathcal{O}$  (if  $c$  has length 1 there are two possibilities). Let*

$$U_c = \tilde{c} \cup \{x \in \partial\mathcal{O} \mid \text{there is a master sequence } A = (a_i) \text{ with } \tilde{a}_1 \subset \tilde{c}\}$$

It is easy to verify that  $U_c$  is always an open set in  $\mathcal{D}$ . In particular it is an open neighborhood of any point in  $U_c \cap \partial\mathcal{O}$ . The rays of  $c$  are equivalent if and only if  $U_c$  is contained in  $\mathcal{O}$ . The notation  $U_c$  will be used from now on.

Given a cyclic order in  $\mathcal{O}$  and  $p, q$  distinct in  $\partial\mathcal{O}$ , let

$$(p, q) := \{x \in \partial\mathcal{O} \mid (p, x, q) \text{ is positive in the cyclic order of } \mathcal{O}\}.$$

This is the interval from  $p$  to  $q$  in the cyclic order. Notice that if one changes the cyclic ordering then  $(p, q)$  of the new cyclic order is  $(q, p)$  of the old cyclic order. So the collection of intervals is independent of the order. Let  $\mathcal{Z}$  be the topology in  $\partial\mathcal{O}$  generated by the intervals. Given  $t$  in  $(p, q)$  there is a master sequence  $A = (a_i)$  for  $t$  with  $U_{a_1} \cap \partial\mathcal{O} \subset (p, q)$ . Hence  $(p, q)$  is open in the topology of  $\partial\mathcal{O}$ . Conversely if  $T$  is open in  $\partial\mathcal{O}$  and  $t \in T$ , there is a master sequence  $A = (a_i)$  satisfying property (b) of definition of the topology in  $\partial\mathcal{O}$ , so that  $U_{a_1} \cap \partial\mathcal{O} \subset T$ . The endpoints of the rays of  $a_1$  are  $p, q$  and then  $t \in (p, q) \subset T$ . So the interval topology is exactly the induced topology in  $\partial\mathcal{O}$ .

**Lemma 3.19.**  *$\mathcal{D}$  is Hausdorff.*

*Proof.* Any two points in  $\mathcal{O}$  are separated from each other. If  $p, q$  are distinct in  $\partial\mathcal{O}$  choose master sequences  $A = (a_i)$  and  $B = (b_i)$ , where  $\tilde{a}_1 \cap \tilde{b}_1 = \emptyset$ . Let  $U_{a_1}$  be the open set of  $\mathcal{D}$  associated to  $a_1$  and  $U_{b_1}$  associated to  $b_1$ . By definition  $U_{a_1}$  is an open neighborhood of  $p$  and likewise  $U_{b_1}$  for  $q$ . They are disjoint open sets of  $\mathcal{D}$ .

Finally if  $p$  is in  $\mathcal{O}$  and  $q$  is in  $\partial\mathcal{O}$ , choose  $U$  a neighborhood of  $q$  coming from a master sequence as above so that  $U \cap \mathcal{O}$  does not have  $p$  in its closure - always possible because master sequences are escaping sets. Hence there are disjoint neighborhoods of  $p, q$ .  $\square$

Our goal is to show that  $\partial\mathcal{O}$  is homeomorphic to  $\mathbf{S}^1$  and that  $\mathcal{D}$  is homeomorphic to a closed disk. We need a few simple results:

**Lemma 3.20.** *For any ray  $l$  of  $\mathcal{O}^s$  or  $\mathcal{O}^u$ , there is an associated point in  $\partial\mathcal{O}$ . Two rays generate the same point of  $\mathcal{O}$  if and only if the rays are equivalent (as rays!).*

*Proof.* Given a ray  $l$  any standard sequence  $(c_i)$  associated to it defines a point in  $\partial\mathcal{O}$ . Let  $r, l$  be rays of  $\mathcal{O}^s, \mathcal{O}^u$ . If they define the same point of  $\partial\mathcal{O}$ , then there is a master sequence  $C = (c_i)$  for this point. Since both standard sequences associated to  $r, l$  are  $\leq C$ , it follows that every  $\tilde{c}_i$  contains subrays of both  $l, r$ . By the fundamental lemma (where we use  $E = F = C$  in that lemma), this occurs if and only if the rays  $r, l$  are equivalent.  $\square$

**Lemma 3.21.** *Suppose that  $A = (a_i)$  is an admissible sequence of polygonal paths and that every  $a_i$  contains a subray of a fixed ray  $l$  of  $\mathcal{O}^s$  or  $\mathcal{O}^u$ . Then  $A$  is associated to the ideal point  $\partial l$  of  $l$  and  $A$  is not a master sequence for the point  $\partial l$  of  $\partial\mathcal{O}$ .*

*Proof.* The point  $\partial l$  was defined just before definition 3.11. The first statement was proved in lemma 3.9. For the second statement, notice that each  $\tilde{a}_i$  is contained in a fixed component of  $\mathcal{O} - l$ . Choose a standard sequence  $B$  associated to  $l$  and cut it along  $l$ . Let  $C$  be the admissible sequence produced so that  $\tilde{c}_1 \cap \tilde{a}_1 = \emptyset$ . This shows that  $A$  is not a master sequence for  $\partial l$ .  $\square$

**Lemma 3.22.** *Let  $A = (a_i)$  be an admissible sequence defining a point  $p$  in  $\partial\mathcal{O}$ . Then one of the following mutually exclusive possibilities occurs:*

(i) *There are infinitely many  $i$  in  $\mathbf{N}$  and for each such  $i$  there is a ray  $l_i$  of  $a_i$  which is equivalent to a fixed ray  $l$  of  $\mathcal{O}^s$  or  $\mathcal{O}^u$ . Then  $p$  is the ideal point of any of the  $l_i$  and  $A$  is not a master sequence for  $p$ . In fact in this case the hypothesis is true for any  $i$  sufficiently big.*

(ii) *There are only finitely many rays of paths in the collection  $\{a_i\}$  which are equivalent to any given ray of  $\mathcal{O}^s$  or  $\mathcal{O}^u$ . In this case  $A$  is a master sequence for  $p$ .*

*Proof.* Most of part (i) was proved in lemma 3.9. The  $\tilde{a}_i$  are nested and hence the rays of  $a_i$  are split into two sequences  $(r_i), (l_i)$  each of which is also “nested”. It is easy to check that only elements of one of the sequences can be equivalent to  $l$ . But if (say)  $r_i$  and  $r_j$  (with  $j > i$ ) are both equivalent to  $l$ , then  $r_k$  is equivalent to  $l$  for any  $i < k < j$ . Hence the  $r_i$  are equivalent to  $p$  for any sufficiently big  $i$ . It does not follow however that for any big  $i, j$ ,  $r_i$  and  $r_j$  share a subray. This is because there may be an infinite perfect fit, so the rays  $r_i$  can change with  $i$  escaping in the horoball model of an infinite perfect fit. Finally a standard sequence for the ray  $l$  and cutting shows that  $A$  is not a master sequence for  $\partial l$ . This proves (i).

To prove part (ii), let  $A = (a_i)$  be an admissible sequence so that there are only finitely many rays of  $(a_i)$  which are equivalent to any given ray of  $\mathcal{O}^s$  or  $\mathcal{O}^u$ . Suppose by way of contradiction that  $A$  is not a master sequence for  $p$ , so there is  $B \cong A$  and  $B \not\leq A$ . Fix some  $n$  so that for no  $j$ ,  $\tilde{b}_j \subset \tilde{a}_n$ . Hence this is true for any  $n' > n$ .

The first possibility is there are  $i, j$ , with  $\tilde{b}_j \cap \tilde{a}_i = \emptyset$ . let  $E = (e_k)$  be an admissible sequence with  $A \leq E, B \leq E$ . Choose  $k > i, j$ , hence  $\tilde{b}_k \cap \tilde{a}_k = \emptyset$  and so that  $a_k$  does not have any rays equivalent to any rays of  $a_i$ . Then any  $\tilde{e}_m, m \geq k$  contains a fixed subray of  $b_k$  and a fixed subray of  $a_k$  and they are not equivalent by choice of  $k$ . This is disallowed by the fundamental lemma.

The second possibility is that  $\tilde{b}_j \cap \tilde{a}_i \neq \emptyset$  for any  $i, j$ . Fix  $k > n$  so that  $a_k$  does not have any ray equivalent to a ray of  $a_n$ . If the 2 rays of  $b_j$  have subrays contained in  $\tilde{a}_n \cup a_n$  then  $\tilde{b}_j - (\tilde{a}_j \cup a_j)$  is contained in a compact set of  $\mathcal{O}$  and as seen before this implies that for some  $t > j$ , then  $\tilde{b}_t \subset \tilde{a}_n$ , contrary to choice of  $n$  in part (ii). We conclude that for any sufficiently big  $m$ ,  $\tilde{b}_m \cup b_m$  is not contained in  $\tilde{a}_n \cup a_n$  but has to intersect  $\tilde{a}_k$ . This implies that for big  $m$ ,  $\tilde{b}_m$  has to contain a subray of a ray of  $a_n$  and a subray of a ray of  $a_k$ . Again this is disallowed by the fundamental lemma. This finishes the proof of the lemma.  $\square$

**Lemma 3.23.** *The space  $\mathcal{D}$  is first countable.*

*Proof.* Let  $p$  be a point in  $\mathcal{D}$ . The result is clear if  $p$  is in  $\mathcal{O}$  so suppose that  $p$  is in  $\partial\mathcal{O}$ . Let  $A = \{a_i\}$  be a master sequence associated to  $p$ . We claim that  $\{U_{a_i}, i \in \mathbf{N}\}$  is a neighborhood basis at  $p$ . Let  $U$  be an open set containing  $p$ . By definition 3.15 there is  $i_0$  with  $\tilde{a}_{i_0} \subset U$  and if  $z$  in  $\partial\mathcal{O}$  admits a master

sequence  $B = (b_i)$  so that for some  $j_0$  then  $\tilde{b}_{j_0} \subset \tilde{a}_{i_0}$  then  $z$  is in  $U$ . By the definition of  $U_{a_{i_0}}$ , it follows that  $U_{a_{i_0}} \subset U$ . Hence the collection  $\{U_{a_i}, i \in \mathbf{N}\}$  forms a neighborhood basis at  $p$ .  $\square$

More importantly we have the following:

**Lemma 3.24.** *The space  $\mathcal{D} = \mathcal{O} \cup \partial\mathcal{O}$  is second countable.*

*Proof.* We first construct a candidate for a countable basis. Since  $\mathcal{O}$  is homeomorphic to  $\mathbf{R}^2$  it has a countable basis  $\mathcal{B}_1$ . Let  $\mathcal{Z} = \{l \mid l \text{ is a periodic leaf of } \mathcal{O}^s \cup \mathcal{O}^u\}$ . Let

$$\mathcal{B}_2 = \{ U_{b_i} \mid b_i \in B = (b_i), B \text{ admissible, where } b_i \text{ has all sides contained in leaves in } \mathcal{Z} \}$$

There are countably many leaves in  $\mathcal{Z}$  and so countably many intersections of these leaves. Since any polygonal path is a union of a finite number of sides, it now follows that  $\mathcal{B}_2$  is a countable collection of open sets in  $\mathcal{D}$ . We want to show that  $\mathcal{B} = \mathcal{B}_1 \cup \mathcal{B}_2$  is a basis for the topology in  $\mathcal{D}$ .

Let  $p$  in  $\mathcal{D}$  and  $V$  open set in  $\mathcal{D}$  containing  $p$ . If  $p$  is in  $\mathcal{O}$  there is  $U$  in  $\mathcal{B}_1$  with  $p \in U \subset V$ . Suppose then that  $p$  is in  $\partial\mathcal{O}$ . Choose  $A = (a_i)$  a master sequence for  $p$ . According to definition 3.15 there is  $j$  with  $U_{a_j} \subset V$ .

We now modify the sides of the  $a_j$  to a convex polygonal path with sides in  $\mathcal{Z}$ . The sides of  $a_j$  in periodic leaves are left unchanged. A side in a non periodic leaf is pushed slightly in the direction of  $\tilde{a}_j$  to a periodic leaf. Notice that the union of periodic leaves of  $\mathcal{O}^s$  (or  $\mathcal{O}^u$ ) is dense in  $\mathcal{O}$ . The proof is done in 2 steps. First we do this for the finite sides. The obstruction to pushing in a side of  $a_j$ , still intersecting the same adjacent sides is that there is a singularity in this side. But then this segment is already in a periodic leaf and we leave it unchanged. Do this for all finite sides of  $a_i$  to produce a new polygonal path  $b_i$ . Do this for all  $i$ . Given  $i$ , then since  $a_j$  escapes in  $\mathcal{O}$  with increasing  $j$ , then the finite segments of  $a_j$  are eventually contained in  $\tilde{b}_i$ . Hence the finite segments of  $b_j$  are contained in  $\tilde{b}_i$ . One can then take a subsequence of the  $(b_i)$  so that  $B = (b_i)$  is nested. The  $b_i$  are convex and also  $(b_i)$  is eventually nested with the  $(a_i)$ . This implies that  $B = (b_i)$  is also a master sequence for  $p$ .

The second step is to modify the rays of  $B = (b_i)$  to be in periodic leaves. Given  $i$ , consider one ray  $l$  of  $b_i$  and  $l_t$ ,  $t \geq 0$  leaves of the same foliation as  $l$ , with  $l_t$  converging to  $l$  as  $t \rightarrow 0$ . In addition the  $l_t$  intersect the side of  $b_i$  adjacent to  $l$ . Note that this intersection of  $l$  and the adjacent side is not a singular point, otherwise  $l$  is periodic and we do not need to change it. If the  $l_t$  converges to another leaf (in  $b_i$  or not) besides  $l$ , then  $l$  is in a non Hausdorff leaf and theorem 2.6 implies that  $l$  is in a periodic leaf and again we leave  $l$  as is. So we may assume that as  $t \rightarrow 0$  then  $l_t$  converges only to the leaf of  $\mathcal{O}^s$  or  $\mathcal{O}^u$  containing  $l$ . There is  $j_i > i$  so that  $l$  does not have a subray which is a side of  $b_{j_i}$  – otherwise  $B = (b_j)$  would not be a master sequence, by lemma 3.22. Then there is  $t$  sufficiently small so that  $l_t$  separates  $l$  from  $b_{j_i}$ . This is true because  $l_t$  does not converge to any other leaf besides  $l$ . Choose also one  $t$  for which  $l_t$  is a periodic leaf and replace the ray  $l$  of  $b_i$  by this ray of  $l_t$ . After doing this to both rays of  $b_i$  this produces a convex polygonal path  $(c_i)$ . For each  $i$  then  $\tilde{b}_{j_i} \subset \tilde{c}_i$ , so  $\tilde{c}_{j_i} \subset \tilde{c}_i$ . So after taking a subsequence  $C = (c_n)$  is nested. By the above,  $C \cong B$  and  $C$  is a master sequence for  $p$ .

Hence we can find  $n$  with  $U_{c_n} \subset V$ . But all the sides of  $c_n$  are periodic. This shows that  $\mathcal{B}$  is a basis for the topology of  $\mathcal{D}$  and finishes the proof of the lemma.  $\square$

Next we show that  $\mathcal{D}$  is a regular space, which will imply that  $\mathcal{D}$  is metrizable.

**Lemma 3.25.** *The space  $\mathcal{D}$  is a regular space.*

*Proof.* Let  $p$  be a point in  $\mathcal{D}$  and  $V$  be a closed set not containing  $p$ . Suppose first that  $p$  is in  $\mathcal{O}$ . Here  $V^c$  is an open set with  $p$  in  $V^c$ , so there are open disks  $D_1, D_2$  in  $\mathcal{O}$ , so that  $p \in D_1 \subset \overline{D_1} \subset D_2 \subset V^c$ , producing disjoint neighborhoods  $D_1$  of  $p$  and  $(D_2)^c$  of  $V$ .

Suppose now that  $p$  is in  $\partial\mathcal{O}$ . Since  $p$  is not in the closed set  $V$ , there is an open set  $O$  of  $\mathcal{D}$  containing  $p$  and disjoint from  $V$ . Let  $A = (a_i)$  be a master sequence associated to  $p$ . Then there is  $i_0$  so that  $U_{a_{i_0}}$

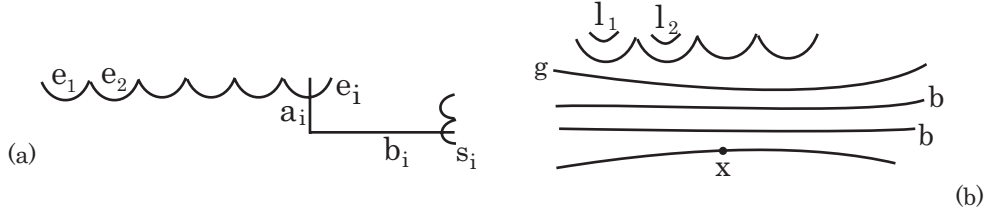

Figure 11: *a. Infinitely many non separated leaves converge to a single ideal point, b. A more interesting situation.*

defined above is contained in  $O$ . We claim that the closure of  $\tilde{a}_{i_0}$  in  $\mathcal{D}$  is  $U_{i_0}$  union  $a_{i_0}$  plus the two ideal points of the rays in  $a_{i_0}$ . Clearly the closure of  $\tilde{a}_{i_0}$  in  $\mathcal{D}$  intersected with  $\mathcal{O}$  is obtained by just adjoining  $a_{i_0}$ . An ideal point of a ray  $l$  of  $a_i$  is clearly in the closure as any neighborhood of it contains a subray of  $l$ . Any other point  $p$  in  $\partial\mathcal{O}$ , if it is in  $U_{a_{i_0}}$ , then it is in the closure of  $\tilde{a}_{i_0}$ . If  $p$  is not in  $U_{i_0}$  and is not an ideal point of  $a_{i_0}$  then find a master sequence for  $p$  disjoint from master sequences of both ideal points of  $a_{i_0}$  and hence disjoint from  $U_{i_0}$ . Hence  $p$  is not in the closure of  $\tilde{a}_{i_0}$ . This proves the claim.

Choose  $j$  big enough so that the rays of  $a_j$  are not equivalent to any ray of  $a_{i_0}$ , again possible by lemma 3.22. By the above it follows that the closure of  $\tilde{a}_j$  is contained in  $U_{a_{i_0}}$ , hence

$$p \in U_{a_j} \subset \text{closure}(\tilde{a}_j) \subset U_{a_{i_0}} \subset O \subset V^c$$

This proves that  $\mathcal{D}$  is regular.  $\square$

**Corollary 3.26.** *The space  $\mathcal{D}$  is metrizable.*

*Proof.* Since  $\mathcal{D}$  is second countable and regular, the Urysohn metrization theorem (see [Mu] pg. 215) implies that  $\mathcal{D}$  is metrizable.  $\square$

Therefore in order to prove that  $\mathcal{D}$  is compact it suffices to show that any sequence in  $\mathcal{D}$  has a convergent subsequence. But it is quite tricky to get a handle on an arbitrary sequence of points in  $\mathcal{O}$  or in  $\partial\mathcal{O}$  and the proof that  $\mathcal{D}$  is compact is hard. This is the key property of  $\mathcal{D}$ . We first analyse one case which seems very special, but which in fact implies the general case without much additional work. Its proof is very involved because there are many cases to consider. First a preliminary result involving non separated leaves. By theorem 2.6 this does not occur in the case without perfect fits.

**Lemma 3.27.** *Let  $\{E_i\}_{i \in \mathbf{Z}}$  be leaves of (say)  $\mathcal{O}^s$  which are all non separated from each other and ordered as in theorem 2.6. Associated to this collection there are two ideal points of  $\mathcal{O}$ , one for  $(E_i)$  with  $i$  converging to infinity and another one for  $(E_i)$  with  $i$  converging to minus infinity. A master sequence for any one of them is obtained with polygonal paths with length 2.*

*Proof.* As explained in the end of section 2, the collection  $\{E_i\}$  is part of the boundary of a scalloped region  $\mathcal{S}$ . We will follow the notation from that section. The region  $\mathcal{S}$  is the union of infinitely many lozenges  $A_i$  and parts of their boundaries so that a half leaf of  $E_i$  is contained in the boundary of  $A_{2i}$  and another half leaf of  $E_i$  is contained in the boundary of  $A_{2i-1}$ . The lozenges  $A_i$  and  $A_{i+1}$  are adjacent for any  $i \in \mathbf{Z}$  and they all intersect a single stable leaf  $C$ . This is depicted in fig. 3. Let  $\gamma_i$  be the periodic orbits in  $E_i$ . The collection of lozenges  $\{A_i\}$  also creates another bi-infinite collection  $\{G_i\}$ ,  $i \in \mathbf{Z}$  of leaves of  $\mathcal{O}^s$ , all of which are non separated from each other and  $G_i$  has a half leaf in the boundary of  $A_{2i}$  and another half leaf in the boundary of  $A_{2i+1}$ . Let  $\delta_i$  be the periodic orbit in  $G_i$ . The boundary of  $\mathcal{S}$  also has two bi-infinite collections of non separated leaves from  $\mathcal{O}^u$ :  $\{S_j\}_{j \in \mathbf{Z}}$  and  $\{T_j\}_{j \in \mathbf{Z}}$ . These are chosen so that  $\widetilde{W}^u(\gamma_i)$  converges to  $\{S_j\}$  when  $i \rightarrow \infty$  and  $\widetilde{W}^u(\gamma_i)$  converges to  $\{T_j\}$  when  $i \rightarrow -\infty$ . In addition  $S_j$  has a periodic orbit  $\tau_j$  and we choose the indexing so that  $\widetilde{W}^s(\tau_j)$  converges to  $\{E_i\}$  when  $i \rightarrow \infty$  and  $\widetilde{W}^s(\tau_j)$  converges to  $\{G_i\}$  when  $i \rightarrow -\infty$ . The collections  $\{G_i\}, \{S_j\}$  are ordered with increasing  $i, j$ , see also theorem 2.6.

Now we define the ideal point associated to  $\{E_i\}_{i \in \mathbf{Z}}$  when  $i$  converges to  $\infty$ . For each positive  $i$  choose rays  $a_i$  in  $\mathcal{O}^u$ ,  $b_i$  in  $\mathcal{O}^s$  which intersect only in their starting point  $u_i$  which is a point in  $\mathcal{S}$  and  $a_i$  intersects  $E_i$  and  $b_i$  intersects  $S_i$ , see fig. 11, a. Let  $d_i = a_i \cup b_i$ , let  $\tilde{d}_i$  be the component of  $\mathcal{O} - d_i$  which contains  $E_k$  for  $k > i$  and  $S_k$  for  $k > i$ . The  $d_i$  are polygonal paths of length 2. It follows that  $d_i$  is convex for  $\tilde{d}_i$ . This uses the particular ordering in  $\{E_i\}, \{S_j\}$  described above and it also follows that  $(d_i)$  is a nested sequence of polygonal paths.

In the explicit model  $(V)$  for a scalloped region given in the end of section 2 we can choose

$$u_i = \left(1 - \frac{1}{2i-1}, 1 - \frac{1}{2i-1}\right), \quad a_i \cap \bar{\mathcal{S}} = \left\{1 - \frac{1}{2i-1}\right\} \times \left[1 - \frac{1}{2i-1}, 1\right], \quad b_i \cap \bar{\mathcal{S}} = \left[1 - \frac{1}{2i-1}, 1\right] \times \left\{1 - \frac{1}{2i-1}\right\}.$$

Notice that the ray  $a_i$  of  $\mathcal{O}^u$  is clearly not contained in  $\bar{\mathcal{S}}$ , only the part contained in  $\bar{\mathcal{S}}$  has a description in the explicit model. Similarly the ray  $b_i$  of  $\mathcal{O}^s$  is not contained in  $\bar{\mathcal{S}}$ . It remains to check that the sequence  $(d_i)$  escapes compact sets in  $\mathcal{O}$  as  $i \rightarrow \infty$ . In the explicit model the  $a_i$  are subsets of the leaves  $\widetilde{W}^u(\gamma_i)$ . Any point in the limit of the sequence  $(\widetilde{W}^u(\gamma_i))$  is non separated from the  $\{S_j\}_{j \in \mathbf{Z}}$  and hence has to be in one of the  $S_j$ . It follows that the part of  $a_i$  outside  $\bar{\mathcal{S}}$  escapes compact sets in  $\mathcal{O}$ . By construction the sequence made up of the parts of  $a_i$  in  $\bar{\mathcal{S}}$  also does not limit in  $\mathcal{O}$ , hence  $(a_i)$  escapes compact sets in  $\mathcal{O}$ . The same is true for  $(b_i)$  so  $(d_i)$  escapes compact sets in  $\mathcal{O}$  and so  $D = (d_i)$  is admissible and defines an ideal point  $p$  of  $\mathcal{O}$ . This  $p$  is associated to the positive infinite direction of the  $\{E_i\}_{i \in \mathbf{Z}}$ . By lemma 3.22,  $D$  is a master sequence. Similarly associated to the negative direction of the  $\{E_i\}$  there is another ideal point  $q$  of  $\mathcal{O}$ .  $\square$

An ideal point  $p$  associated to infinitely many non separated leaves or equivalently to a scalloped region is called a *corner* of the scalloped region.

The technical lemma in the special case is the following:

**Lemma 3.28.** *Let  $(l_i), i \in \mathbf{N}$  be a sequence of line leaves of  $\mathcal{O}^s$  (or  $\mathcal{O}^u$ ) and let  $z_i$  in  $l_i$ . Suppose that for each  $i$  the set  $\mathcal{O} - l_i$  has a component  $C_i$  so that each  $C_i \cup l_i$  contains  $\mathcal{O}^s(z_i)$  and also that the collection  $\{C_i \cup l_i\}$  is pairwise disjoint. Suppose that the ordering of  $l_i$  (see definition 3.12) is chosen so that the  $l_i$  are linearly ordered with  $i$ . Then in  $\mathcal{D}$ , the sequence  $(C_i \cup l_i)$  converges to a point  $p$  in  $\partial\mathcal{O}$ .*

*Proof.* The proof of this lemma is very involved because there are many possibilities and many places where the leaves  $l_i$  can slip through.

Suppose that  $l_i$  is always in  $\mathcal{O}^s$  as other cases are similar. If the  $l_i$  does not escape compact sets in  $\mathcal{O}$  when  $i \rightarrow \infty$  then there are  $i_k$  and  $z_{i_k}$  in  $l_{i_k}$  with  $z_{i_k}$  converging to a point  $z$ . But then the  $C_{i_k}$  cannot all be disjoint, contradiction. Hence the  $(l_i)$  escapes in  $\mathcal{O}$ .

First notice that because the collection  $\{l_i\}$  is linearly ordered with  $i$ , then if a subsequence  $(l_{i_k} \cup C_{i_k})$  converges to  $p$  in  $\mathcal{D}$ , then the full sequence  $(l_i \cup C_i)$  also converges to  $p$  in  $\mathcal{D}$ . Choose  $z_i$  in  $l_i$ .

Case 1 – There is an infinite subsequence of the  $(l_j)$ , which we may assume is the original sequence so that  $l_j$  are all non separated from  $l_1$  (in particular there are perfect fits).

Then the  $\{l_j, j \in \mathbf{N}\}$  forms a subcollection of a collection  $\{z_i\}_{i \in \mathbf{Z}}$  of non separated leaves of  $\mathcal{O}^s$  as in lemma 3.27. Hence we can find  $a_j, b_j$  as in the previous lemma and for any  $i$ ,  $l_i$  intersects  $a_{j_i}$  where  $j_i$  goes to infinity with  $i$ . As in the lemma let  $d_j = a_j \cup b_j$  and  $D = (d_j)$ . Then  $D$  is a master sequence defining a point  $p$  in  $\partial\mathcal{O}$ . In addition given any  $j$  then for  $i$  big enough  $l_i$  is contained in  $\tilde{d}_j$ . Hence  $l_i \cup C_i$  converges to  $p$  in  $\mathcal{D}$ .

Case 2 – Up to subsequence, for any distinct  $i, j$ , the  $l_i$  is separated from  $l_j$ .

Let  $V = \mathcal{O} - \bigcup_{i \in \mathbf{N}} (C_i \cup l_i)$ , an open set in  $\mathcal{O}$ . The procedure will be to inductively construct leaves  $g_n$  so that either the sequence  $(g_n), n \in \mathbf{N}$  is nested with  $n$  and escapes compact sets in  $\mathcal{O}$  or is a sequence of non separated leaves. There are various possibilities for the limiting behavior of  $(g_j)$  which will eventually lead to a proof that  $(l_i \cup C_i)$  converges in  $\mathcal{D}$ .

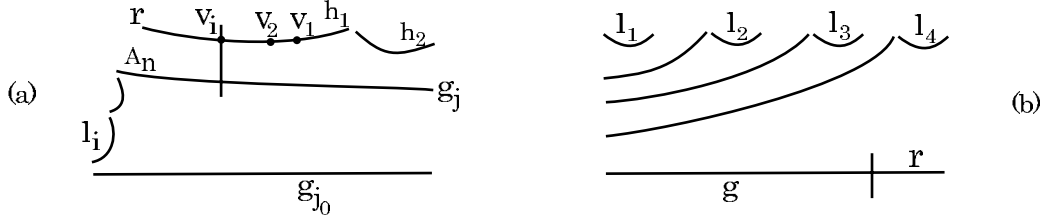

Figure 12: a. Forcing convergence on one side, b. The case that all  $g_j$  are equal.

Given  $x$  in  $\mathcal{O}$  consider the line leaves  $b$  of  $\mathcal{O}^s$  which separate  $x$  from ALL of the  $l_i$ . For example given  $y$  not in the union of  $l_i \cup C_i$ , then  $\mathcal{O}^s(y)$  is disjoint from this union – this is because no prong of  $\mathcal{O}^s(z_i)$  is contained in  $V$ . For any  $x$  in a complementary region of  $\mathcal{O}^s(y)$  not intersecting this union will have such line leaves  $b$ . A singular leaf has at most two line leaves with this property. The collection of line leaves  $b$  as above is clearly ordered by separation properties so we can index them as  $\{b_\alpha \mid \alpha \in J\}$  where  $J$  is an index set. Put an order in  $J$  so that  $\alpha < \beta$  if and only if  $b_\alpha$  separates some point in  $b_\beta$  from  $x$ . Equivalently  $b_\beta$  separates some point in  $b_\alpha$  from  $x$ . Two such line leaves in the same stable leaf may share the singular point or a half leaf. Since the  $b_\alpha$  cannot escape  $\mathcal{O}$  as  $\alpha$  increases (they are bounded by all the  $l_i$ ) then the  $\{b_\alpha\}$  limits to a collection of leaves of  $\mathcal{O}^s$  as  $\alpha$  grows without bound.

There are 2 options: 1) There are infinitely many line leaves  $s_n$  of  $\mathcal{O}^s$  in the limit of the  $b_\alpha$  so that for each  $n$  there is  $i_n$  with  $s_n$  either equal to  $l_{i_n}$  or separating  $l_{i_n}$  from every  $b_\alpha$ , 2) There is one line leaf  $s$  of  $\mathcal{O}^s$  in the limit of the  $b_\alpha$  so that this single  $s$  separates infinitely many of the  $l_i$  from all of the  $g_\alpha$ . Notice that only option 2) can happen when there are no perfect fits.

Consider first option 1. The collection of leaves non separated from the  $s_n$  is infinite. Because the  $l_i$  are ordered it now follows that each  $s_n$  can separate only finitely many of the  $l_i$  from all of the  $b_\alpha$ . Let  $p$  be the ideal point given by lemma 3.27 associated to the direction of the  $s_n$  with  $n$  increasing. The proof of lemma 3.27 implies that  $(l_i \cup C_i)$  converges to  $p$ .

Now consider option 2. Let  $g_0 = s$ . The leaf  $t$  of  $\mathcal{O}^s$  containing  $s$  may have singularities. By the condition of pairwise disjointness of the  $l_i \cup C_i$ , there is a single line leaf  $g_1$  of  $t$  with a complementary component  $o_1$  in  $\mathcal{O}$  which contains  $l_i$  for all  $i \geq i_0$ . We will restart the process with the  $\{l_i\}, i \geq i_0$  instead of the original sequence. We will remember  $g_0$  and the leaf  $g_1$  which separates  $x$  from all  $l_i \cup C_i, i \geq i_0$ .

Restart the process as follows. Throw out all the leaves until  $l_{i_0}$  and redo the process. This iterative process produces  $(g_j), j \in \mathbf{N}$  which is a weakly nested sequence of line leaves. We explain the weak behavior. For instance in the first case, after throwing out  $l_1$  (or whatever first leaf was still present), it may be that only  $g_1$  is a slice which separates  $x$  from all other  $l_i$ , see fig. 12, b. In that case  $g_2 = g_1$ . So the  $g_j$  may be equal, but they are weakly monotone with  $j$ .

If the  $(g_j)$  escapes in  $\mathcal{O}$  with  $j$  then it defines a point  $p$  in  $\partial\mathcal{O}$ . Since each  $g_j$  separates infinitely many  $l_i$  from  $x$  we quickly obtain as before that the  $l_i$  converge to the point  $p$  in  $\partial\mathcal{O}$ .

Suppose then that the  $(g_j)$  does not escape in  $\mathcal{O}$ . The first option is that there are infinitely many distinct  $g_j$ . Up to taking a subsequence assume all  $g_j$  are distinct and let  $g_j$  converge to  $H = \cup h_k$ , a collection of line leaves of  $\mathcal{O}^s$ . By construction, for each  $j_0$ , the  $g_{j_0}$  separates some  $l_i$  from  $x$  but for a bigger  $j$ , the  $g_j$  does not separate  $l_i$  from  $x$ , see fig. 12, a. Also, for each  $i$  there is some  $j$  so that  $g_j$  separates  $l_i$  from  $x$ . In particular there is a component of  $\mathcal{O} - H$  which contains all the  $l_i$ .

We analyse the case there are finitely many line leaves of  $\mathcal{O}^s$  in  $H$ , the other case being similar. As seen in theorem 2.6 the set of leaves in  $H$  is ordered and we choose  $h_1$  to be the leaf closest to the  $l_i$ . Also there is a ray  $r$  of  $l$  which points in the direction of the  $l_i$ , see fig. 12, a. Let  $p$  be the ideal point of  $r$  in  $\partial\mathcal{O}$ . We want to show that  $l_i \cup C_i$  converges to  $p$ .

Choose points  $v_n$  in  $r$  converging to  $p$ . For each  $n$  then  $\mathcal{O}^u(v_n)$  intersects  $g_j$  for  $j$  big enough – since the sequence  $g_j$  converges to  $H$ . Choose one such  $g_{j(n)}$  with  $j(n)$  converging to infinity with  $n$ . We consider a convex set  $A_n$  of  $\mathcal{O}$  bounded by a subray of  $r$  starting at  $v_n$ , a segment in  $\mathcal{O}^u(v_n)$  between  $h_1$



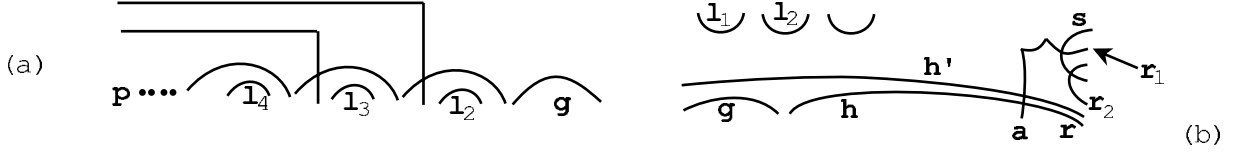

Figure 13: *a. The  $l_i$  flip to the other side of a leaf non separated from  $g$ , b. Convex neighborhood disjoint from all.*

and  $g_{j(n)}$  and a ray in  $g_{j(n)}$  starting in  $g_{j(n)} \cap \mathcal{O}^u(v_n)$  and going in the direction of the  $l_i$ , see fig. 12, a. We can choose  $j(n)$  so that the  $(A_n), n \in \mathbf{N}$  forms a nested sequence. Let  $a_n = \partial A_n$ . Since  $h_1$  is the first element of  $H$  it follows that  $(a_n)$  escapes compact sets in  $\mathcal{O}$  and clearly it converges to  $p$  in  $\mathcal{O} \cup \partial\mathcal{O}$ . For each  $n$  and associated  $j$ , there is  $i_0$  so that for  $i > i_0$  then  $g_j$  separates  $l_i$  from  $x$ . It follows that  $l_i \cup C_i$  is contained in  $A_n$  and therefore  $(l_i \cup C_i)$  converges to  $p$  in  $\mathcal{D}$ . This finishes the proof in this case.

If  $H$  is infinite let  $H = \{h_k, k \in \mathbf{Z}\}$  with  $k$  increasing as  $h_k$  moves in the direction of the  $l_i$ . Then  $h_i$  converges to a point  $p \in \mathcal{O}$ . A similar analysis as in the case that  $H$  is finite shows that  $(l_i \cup C_i)$  converges to  $p$  in  $\mathcal{D}$ . Use the convex chains  $a_j \cup b_j$  as described in lemma 3.27.

The final case to be considered is that up to subsequence all  $g_i$  are equal and let  $g$  be this leaf. In particular no  $l_i$  is equal to  $g$ . This can certainly occur as shown in fig. 12, b. If we remove finitely many of the  $l_i$ , then  $g$  is still the farthest leaf separating  $x$  from all the remaining  $l_i$ . Notice also the  $g$  is a line leaf on the side containing all the  $l_i$ .

Consider the collection of leaves  $\mathcal{B}$  of  $\mathcal{O}^s$  non separated from  $g$  in the side of  $g$  containing the  $l_i$ . Let  $W$  be the component of  $\mathcal{O} - \mathcal{B}$  which accumulates on all of  $\mathcal{B}$  if  $\mathcal{B} \neq \{g\}$  and otherwise let  $W$  be the component of  $\mathcal{O} - \{g\}$  not containing  $x$ .

One possibility is that there are infinitely many  $i$  so that  $l_i$  is separated from  $g$  by an element in  $\mathcal{B}$ . Here we have 2 options. The first option is that there are infinitely many distinct elements  $e$  in  $\mathcal{B}$  for which there is some  $l_i$  with  $e$  separating  $l_i$  from  $g$ , see fig. 13, a. Since the  $l_i$  are nested then as seen before this implies that the  $l_i \cup C_i$  converge to some  $p$  in  $\partial\mathcal{O}$ . The second option here is that there is some fixed  $h'$  in  $\mathcal{B}$  which separates infinitely many  $l_i$  from  $g$ . As the sequence  $(l_i)$  is nested, this is true for all  $i \geq i_0$  for some  $i_0$ . But then  $h'$  would eventually take the place of  $g$  in the iterative process – that is, some  $g_k = h'$  instead of  $g_k = g$ . Then  $g_k$  is not eventually constant and this was dealt with previously.

The remaining case is that after throwing out a few initial terms we may assume that all  $l_i$  are contained  $W$ , see fig. 13, b. Fix an embedded arc  $\gamma$  from  $g$  to  $l_1$  intersecting them only in boundary points and not intersecting any other  $l_i$ . Let  $T$  be the component of  $\mathcal{O} - (g \cup \gamma \cup l_1)$  containing all other  $l_i$ . Put an order in  $\mathcal{B}$  so that elements of  $\mathcal{B}$  contained in  $T$  are bigger than  $g$  in this order. For simplicity assume that  $\mathcal{B}$  is finite. The case where there are infinitely many leaves non separated from  $g$  on that side is very similar with proof left to the reader. Let  $h$  be the biggest element of  $\mathcal{B}$ , which could be  $g$  itself. Let  $r$  be the ray of  $h$  associated to the increasing direction of the the  $l_i$  and let  $p$  in  $\partial\mathcal{O}$  be the ideal point of  $r$ . We want to show that  $(l_i \cup C_i)$  converges to  $p$ .

Let  $A$  be an arbitrary convex neighborhood of  $p$  in  $\mathcal{D}$  bounded by a convex chain  $a$ , see fig. 13, b. If  $A$  is small enough then  $a$  has a ray  $r_1$  contained in  $T$ . The rays  $r, r_1$  are not equivalent. Let  $h'$  be a leaf of  $\mathcal{O}^s$  in  $W$  sufficiently close to  $g$ . Because  $h$  is the biggest element in the ordered set  $\mathcal{B}$  then  $h'$  has to have a ray contained in  $A$ . For  $h'$  close enough to  $g$ , since the  $l_i$  are in  $T$ , then for some  $i_0$  the leaf  $h'$  separates  $l_i, 1 \leq i \leq i_0$  from  $g$  and hence from  $x$ . By the maximality property of  $g$ , then for some  $j$  the leaf  $h'$  does not separate  $l_j$  from  $g$ . Since  $l_j$  is in  $T$  this forces  $l_j$  to be contained in  $A$ . As the  $\{l_i, i \in \mathbf{N}\}$  forms an ordered collection this forces  $l_i$  to be contained in  $A$  for all  $i \geq j$ . Since  $A$  was an arbitrary neighborhood of  $p$  this shows that  $(l_i \cup C_i)$  converges to  $p$  in  $\mathcal{D}$ .

This finishes the proof of lemma 3.28. □

**Proposition 3.29.** *The space  $\mathcal{D}$  is compact.*

*Proof.* Since  $\mathcal{D}$  is metrizable, it suffices to consider the behavior of an arbitrary sequence  $z_i$  in  $\mathcal{D}$ . We analyse all possibilities and in each case show there is a convergent subsequence.

Up to taking subsequences there are 2 cases:

Case 1 – Assume the  $z_i$  are all in  $\mathcal{O}$ .

If there is a subsequence of  $z_i$  in a compact set of  $\mathcal{O}$ , then there is a convergent subsequence as  $\mathcal{O} \cong \mathbf{R}^2$ . So assume from now on that  $z_i$  escapes compact sets in  $\mathcal{O}$ . Let  $b_i = \mathcal{O}^s(z_i)$ . Suppose first there is a subsequence  $(b_{i_k})$  converging to  $b$  and assume that all  $b_{i_k}$  are in one sector of  $b$  or in  $b$  itself. If a subsequence of  $(b_{i_k})$  is constant and hence equal to  $b$  then up to another subsequence the  $z_i$  converges in  $\mathcal{D}$  to one of the ideal points of  $b$ , done. Otherwise a small transversal to  $b$  in a regular unstable leaf intersects  $b_{i_k}$  for  $k$  big enough and up to subsequence assume all  $z_{i_k}$  are in one side of that unstable leaf. Suppose for simplicity there are only finitely many leaves non separated from  $b$  in the side containing the  $b_i$ . Let  $b'$  be the last one non separated from  $b$  in the side the  $b_{i_k}$  are in and let  $p$  be the ideal point of  $b'$  in that direction. The argument is similar to one in case 2 of lemma 3.28: let  $v_n$  in  $b'$  converging to  $p$  in  $\partial\mathcal{O}$  with  $\mathcal{O}^u(v_n)$  regular. Choose a convex polygonal path  $a_n$  made up of the ray in  $b'$  starting in  $v_n$  and converging to  $p$ , then the segment in  $\mathcal{O}^u(v_n)$  from  $v_n$  to  $\mathcal{O}^u(v_n) \cap b_{i_k}$  for appropriately big  $k$  and then a ray in  $b_{i_k}$  starting in this point. As before we can choose the  $\tilde{a}_n$  nested with  $n$  and so that  $(\tilde{a}_n \cup a_n)$  escapes compact sets in  $\mathcal{O}$ , so converges to  $p$  in  $\mathcal{D}$ . It follows that  $z_{i_k}$  converges to  $p$  and we are done in this case. The case of infinitely many leaves non separated from  $l$  is treated similarly to what is done in the proof of lemma 3.28.

Suppose now that the sequence  $(b_i), i \in \mathbf{N}$  escapes compact sets in  $\mathcal{O}$ . The goal is to reduce this case to a situation where we can apply lemma 3.28. Fix a base point  $x$  in  $\mathcal{O}$  and assume that  $x$  is not in any  $b_i$ . Let  $l_i$  be the line leaf of  $b_i$  (so  $l_i$  is a line leaf of  $\mathcal{O}^s$ ) which is the boundary of the component of  $\mathcal{O} - b_i$  containing  $x$ . Let  $C_i$  be the component of  $\mathcal{O} - l_i$  not containing  $x$ . If  $b_i$  is regular then  $C_i$  is a component of  $\mathcal{O} - b_i$ . If  $b_i$  is singular then  $C_i \cup l_i$  contains all the prongs of  $b_i$ . In this case it follows that  $C_i$  escapes compact sets in  $\mathcal{O}$ . If there is a subsequence  $(l_{i_k})$  so that  $(l_{i_k})$  is nested then this defines an admissible sequence of convex polygonal paths (of length one) converging to an ideal point  $p$ .

Otherwise there has to be  $i_1$  so that there are only finitely many  $i$  with  $C_i \subset C_{i_1}$ . Choose  $i_2 > i_1$  with  $C_{i_2} \not\subset C_{i_1}$  and hence  $C_{i_2} \cap C_{i_1} = \emptyset$  and also so that there are finitely many  $i$  with  $C_i \subset C_{i_2}$ . In this way we construct a subsequence  $i_k, k \in \mathbf{N}$  with  $C_{i_k}$  disjoint from each other. The collection of line leaves

$$\{ l_{i_k} \mid k \in \mathbf{N} \}$$

is circularly ordered and if we remove one element of the sequence (say the first one) then it is linearly ordered. As such it can be mapped injectively into the set of rational numbers  $\mathbf{Q}$  in an order preserving way. Therefore there is another subsequence (call it still  $(l_{i_k})$ ) for which the set  $\{l_{i_k}\}$  is now linearly ordered with  $k$  – either increasing or decreasing. We can now apply lemma 3.28 to the sequence  $l_{i_k}$  and obtain that  $(l_{i_k})$  converges to a point  $p$  in  $\partial\mathcal{O}$  and hence so does  $z_{i_k}$ . It was crucial here that  $C_i \cup l_i$  contains all the prongs of  $b_i$  in order to apply lemma 3.28.

This finishes the analysis of case 1.

Case 2 – Suppose the  $z_i$  are in  $\partial\mathcal{O}$ .

We use the analysis of case 1. We may assume that the points  $z_i$  are pairwise distinct. To start we can find a convex polygonal path  $a_1$  so that  $\overline{U}_{a_1}$  contains a neighborhood of  $z_1$  in  $\mathcal{D}$  and also it does not contain any other  $z_i$ . Otherwise there is a subsequence of  $(z_i)$  which converges to  $z_1$ . Inductively construct  $a_i$  convex polygonal paths with  $\overline{U}_{a_i}$  neighborhood of  $z_i$  in  $\mathcal{D}$  and the  $\{\overline{U}_{a_j}\}, 1 \leq j \leq i$  pairwise disjoint. By taking smaller convex neighborhoods we can assume that the  $(U_{a_i})$  escapes compact sets in  $\mathcal{O}$  as  $i \rightarrow \infty$ . As in case 1 we may assume up to subsequence that the  $\{a_i \mid i \in \mathbf{N}\}$  forms an ordered set of  $\mathcal{O}$  with the order given by  $i$ . Let  $w_i$  be a point in  $a_i$ . Since  $a_i$  escapes compact sets in  $\mathcal{O}$ , case 1 implies that there is a subsequence  $w_{i_k}$  converging to a point  $p$  in  $\partial\mathcal{O}$ . Consider a master sequence  $B = (b_j)$  associated to  $p$ . Let  $j$  be an integer. If for all  $k$  we have that  $\tilde{a}_{i_k} \not\subset \tilde{b}_j$ , then  $\tilde{a}_{i_k}$  has a point  $w_{i_k}$  converging to  $p$  and also has points outside  $\tilde{b}_j$ . This contradicts the  $\tilde{a}_{i_k}$  being all disjoint since they

are convex. Therefore  $\tilde{a}_{i_k} \subset \tilde{b}_j$  for  $k$  big enough – this follows because the sequence  $(a_{i_k})$  is ordered as a subset of  $\mathcal{O}$ . In fact by increasing the index if necessary then  $U_{a_{i_k}} \subset \text{closure}(\tilde{b}_j)$  in  $\mathcal{D}$ . Since  $z_{i_k}$  is in  $U_{a_{i_k}}$  this shows that  $z_{i_k} \rightarrow p$ . Therefore there is always a subsequence of the original sequence which converges to a point in  $\partial\mathcal{O}$ .

This finishes the proof of proposition 3.29, compactness of  $\mathcal{D}$ .  $\square$

We now prove a couple of additional properties of  $\mathcal{D}$ .

**Proposition 3.30.** *The space  $\partial\mathcal{O}$  is homeomorphic to a circle.*

*Proof.* The space  $\partial\mathcal{O}$  is metrizable and circularly ordered. Also  $\partial\mathcal{O}$  is compact, being a closed subset of a compact space – since  $\mathcal{O}$  is open in  $\mathcal{D}$ . We now show that  $\partial\mathcal{O}$  is connected, no points disconnect the space and any two points disconnect the space.

Let  $p, q$  be distinct points in  $\partial\mathcal{O}$ . Choose disjoint convex neighborhoods  $\overline{U}_a, \overline{U}_b$  of  $p, q$  defined by convex polygonal paths  $a, b$ . There are ideal points of  $\mathcal{O}$  in  $\overline{U}_a$  distinct from  $p$ , hence there is a point in  $\partial\mathcal{O}$  between  $p, q$ . Hence any “interval” in  $\mathcal{O}$  is a linear continuum, being compact and satisfying the property that between any two points there is another point. This shows that  $\partial\mathcal{O}$  is connected and also that no point in  $\partial\mathcal{O}$  disconnects it. In addition as  $\partial\mathcal{O}$  is circularly ordered, then any two points disconnect  $\partial\mathcal{O}$ . By theorem I.11.21, page 32 of Wilder [Wi], the space  $\partial\mathcal{O}$  is homeomorphic to a circle.  $\square$

We are now ready to prove that  $\mathcal{D}$  is homeomorphic to a disk.

**Theorem 3.31.** *The space  $\mathcal{D} = \mathcal{O} \cup \partial\mathcal{O}$  is homeomorphic to the closed disk  $D^2$ .*

*Proof.* The proof will use classical results of general topology, namely a theorem of Zippin characterizing the closed disk  $\mathbf{D}^2$ , see theorem III.5.1, page 92 of Wilder [Wi].

First we need to show that  $\mathcal{D}$  is a Peano continuum, see page 76 of Wilder [Wi]. A Hausdorff topological space  $C$  is a *Peano space* if it is not a single point, it is second countable, normal, locally compact, connected and locally connected. Notice that Wilder uses the term perfectly separable (definition in page 70 of [Wi]) instead of second countable. If in addition  $C$  is compact then  $C$  is a *Peano continuum*.

By proposition 3.29 our space  $\mathcal{D}$  is compact, hence locally compact. It is also Hausdorff – lemma 3.19 – hence normal. By lemma 3.24 it is second countable and it is clearly not a single point. What is left to show is that  $\mathcal{D}$  is connected and locally connected.

We first show that  $\mathcal{D}$  is connected. Suppose not and let  $A, B$  be a separation of  $\mathcal{D}$ . Since  $\partial\mathcal{O}$  is connected (this is done in the proof of proposition 3.30), then  $\partial\mathcal{O}$  is contained in either  $A$  or  $B$ , say it is contained in  $A$ . Then  $B$  is contained in  $\mathcal{O}$ . If  $B \neq \mathcal{O}$ , then  $B, A \cap \mathcal{O}$  disconnect  $\mathcal{O}$ , contrary to  $\mathcal{O} \sim \mathbf{R}^2$ . If  $B = \mathcal{O}$ , then  $A = \partial\mathcal{O}$  and so  $\mathcal{O}$  is closed in  $\mathcal{O} \cup \partial\mathcal{O}$ , which is not true. It follows that  $\mathcal{D}$  is connected.

Next we show that  $\mathcal{D}$  is locally connected. Since  $\mathcal{O} \cong \mathbf{R}^2$ , then  $\mathcal{D}$  is locally connected at every point of  $\mathcal{O}$ . Let  $p$  in  $\partial\mathcal{O}$  and let  $W$  be a neighborhood of  $p$  in  $\mathcal{D}$ . If  $A = (a_i)$  is a master sequence associated to  $p$ , there is  $i$  with  $\overline{U_{a_i}}$  contained in  $W$  and  $U_{a_i}$  is a neighborhood of  $p$  in  $\mathcal{D}$ . Now  $U_{a_i} \cap \mathcal{O} = \tilde{a}_i$  is homeomorphic to  $\mathbf{R}^2$  also and hence connected. The closure of  $\tilde{a}_i$  in  $\mathcal{D}$  is  $\overline{U_{a_i}}$ . Since

$$\tilde{a}_i \subset U_{a_i} \subset \overline{U_{a_i}}$$

then  $U_{a_i}$  is connected. This shows that  $\mathcal{D}$  is locally connected and hence that  $\mathcal{D}$  is a Peano continuum.

To use theorem III.5.1 of [Wi] we need the idea of spanning arcs. An arc in a topological space  $X$  is a subspace homeomorphic to a closed interval in  $\mathbf{R}$ . Let  $ab$  denote an arc with endpoints  $a, b$ . If  $K$  is a point set, we say that  $ab$  spans  $K$  if  $K \cap ab = \{a, b\}$ . We now state theorem III.5.1 of [Wi].

**Theorem 3.32.** (Zippin) *A Peano continuum  $C$  containing a 1-sphere  $J$  and satisfying the following conditions below is a closed 2-disk with boundary  $J$ :*

- (i)  $C$  contains an arc that spans  $J$ ,
- (ii) Every arc that spans  $J$  separates  $C$ ,
- (iii) No closed proper subset of an arc spanning  $J$  separates  $C$ .

Here  $E$  separates  $C$  mean that  $C - E$  is not connected.

In our case  $J$  is  $\partial\mathcal{O}$ . For condition (i) let  $l$  be a nonsingular leaf in  $\mathcal{O}^s$  or  $\mathcal{O}^u$ . Then  $l$  has 2 ideal points in  $\partial\mathcal{O}$  which are distinct. The closure  $\bar{l}$  is an arc that spans  $\partial\mathcal{O}$ . This proves (i).

We prove (ii). Let  $\zeta$  be an arc in  $\mathcal{D}$  spanning  $\partial\mathcal{O}$ . Then  $\zeta \cap \mathcal{O}$  is a properly embedded copy of  $\mathbf{R}$  in  $\mathcal{O}$ . Hence  $\mathcal{O} - (\zeta \cap \mathcal{O})$  has exactly two components  $A_1, B_1$ . In addition  $\partial\mathcal{O} - (\zeta \cap \partial\mathcal{O})$  has exactly two components  $A_2, B_2$  and they are connected, since  $\partial\mathcal{O}$  is homeomorphic to a circle by proposition 3.30. If  $p$  is in  $A_2$  and  $A = (a_i)$  is a master sequence for  $p$ , then by definition of the topology in  $\mathcal{D}$  there is  $i$  so that that  $U = U_{a_i}$  is disjoint from  $\zeta$  as  $\zeta$  is closed in  $\mathcal{D}$  and  $p \notin \zeta$ . Then  $U \cap \mathcal{O} = U_{a_i} \cap \mathcal{O} = \tilde{a}_i$  is connected. Hence  $U \cap \mathcal{O}$  is contained in either  $A_1$  or  $B_1$ . This also shows that a small neighborhood of  $p$  in  $\partial\mathcal{O}$  will be contained in either  $A_2$  or  $B_2$ . By connectedness of  $A_2, B_2$ , then after switching  $A_1$  with  $B_1$  if necessary it follows that: for any  $p \in A_2$  there is a neighborhood  $U$  of  $p$  in  $\mathcal{D}$  with  $U \cap \zeta = \emptyset$  and  $U \cap \mathcal{O} \subset A_1$ . Similarly  $B_2$  is paired with  $B_1$ . Let  $A = A_1 \cup A_2$  and  $B = B_1 \cup B_2$ . The arguments above show that  $A, B$  are open in  $\mathcal{D}$  and therefore they form a separation of  $\mathcal{D} - \zeta$ . This proves (ii).

Since  $\mathcal{O} - (\zeta \cap \mathcal{O})$  has exactly two components  $A_1, B_1$  then  $\zeta \cap \mathcal{O}$  is contained in  $\overline{A_1} \cap \overline{B_1}$  and so  $\zeta \subset \overline{A} \cap \overline{B}$ . It follows that no proper subset of  $\zeta$  separates  $\mathcal{D}$ . This proves property (iii).

Now Zippin's theorem implies that  $\mathcal{D}$  is homeomorphic to a closed disk. This finishes the proof of theorem 3.31.  $\square$

Notice that  $\pi_1(M)$  acts on  $\mathcal{O}$  by homeomorphisms. The action preserves the foliations  $\mathcal{O}^s, \mathcal{O}^u$  and also preserves convex polygonal paths, admissible sequences, master sequences and so on. Hence  $\pi_1(M)$  also acts by homeomorphisms on  $\mathcal{D}$ . The next result will be very useful in the following section.

**Proposition 3.33.** *Let  $\Phi$  be a pseudo-Anosov flow in  $M^3$  closed. Let  $p$  be an ideal point of  $\mathcal{O}$ . Then one of the 3 mutually exclusive options occurs:*

- 1) *There is a master sequence  $L = (l_i)$  for  $p$  where  $l_i$  are slices in leaves of  $\mathcal{O}^s$  or  $\mathcal{O}^u$ .*
- 2)  *$p$  is an ideal point of a ray  $l$  of  $\mathcal{O}^s$  or  $\mathcal{O}^u$  so that  $l$  makes a perfect fit with another ray of  $\mathcal{O}^s$  or  $\mathcal{O}^u$ . There are master sequences which are standard sequences associated to the ray  $l$  in  $\mathcal{O}^s$  or  $\mathcal{O}^u$  as described in definition 3.8.*
- 3)  *$p$  is a corner of a scalloped region as described in section 2. Then a master sequence for  $p$  is obtained as described in lemma 3.27.*

*In addition the only conclusion that applies if there are no perfect fits is conclusion 1).*

*Proof.* The point  $p \in \mathcal{O}$  is fixed in this proof. We first show that cases 1) - 3) are mutually exclusive. Case 2) it is disjoint from case 1). This is because any master sequence  $E = (e_i)$  in case 2) has to have  $\tilde{e}_i$  containing part of a fixed perfect fit for  $i$  big enough. In particular the polygonal paths  $e_i$  have to have at least 2 sides for  $i$  big enough, so this cannot be case 1). Suppose now that  $p$  is a point of type 3). Consider a master sequence  $D = (d_i)$  where  $d_i = a_i \cup b_i$ ,  $a_i$  a ray in  $\mathcal{O}^u$  and  $b_i$  a ray in  $\mathcal{O}^s$  as described in lemma 3.27. Notice that all  $a_i$  intersect a common unstable leaf. If there is a master sequence  $L = (l_j)$  as in 1) then the  $l_j$  have to weakly intercalate with the  $d_i$ . But then they have to separate leaves of  $\mathcal{O}^u$  intersecting a common leaf of  $\mathcal{O}^s$  and vice versa. This is impossible. The same argument can be used to rule out case 2): consider a master sequence  $E = (e_j)$  as in case 2). The weak intercalation property of  $d_i$  with this sequence implies that the polygonal paths  $e_j$  have to be eventually of length 2 and both leaves have to be leaves intersecting the scalloped region. Hence  $E$  is an admissible sequence as in Case 3) and does not converge to an ideal point of a ray  $l$  associated to a perfect fit.

Now we prove that one of options 1) - 3) has to occur. Fix a basepoint  $x$  in  $\mathcal{O}$ . Let  $A = (a_i)$  be a master sequence defining  $p$ . Since  $(a_i \cup \tilde{a}_i)$  escapes compact sets in  $\mathcal{O}$ , we may throw out a few initial terms if necessary and assume that  $x$  is not in the closure of any  $\tilde{a}_i$ . Each  $a_i$  is a convex polygonal path,  $a_i = b_1 \cup \dots \cup b_n$  where  $b_j$  is either a segment or a ray in  $\mathcal{O}^s$  or  $\mathcal{O}^u$ . For simplicity we omit the dependence of the  $b_j$ 's on the index  $i$ .

**Claim** – For each  $i$  there is some  $b_j$  as above, with  $b_j$  contained in a slice  $z$  of a leaf of  $\mathcal{O}^s$  or  $\mathcal{O}^u$ , so that  $z$  separates  $x$  from  $\tilde{a}_i$ .

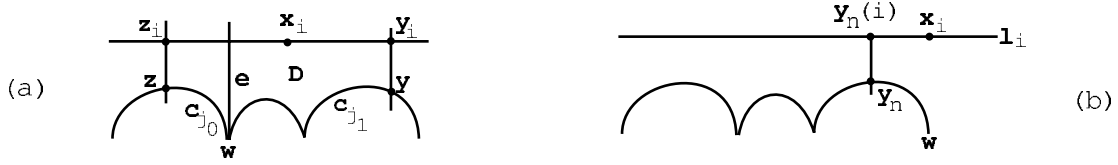

Figure 14: *a. The case that  $x_i$  is between some unstable leaves, b. The case  $x_i$  escapes to one side.*

In this claim  $i$  is fixed. Given  $j$  let  $y$  be an endpoint of  $b_j$ . Wlog assume  $b_j$  is in a leaf of  $\mathcal{O}^s$  and  $y$  is in  $b_{j+1}$  also. Since  $a_i$  is a convex polygonal path, we can extend  $b_j$  along  $\mathcal{O}^s(y)$  beyond  $y$  and entirely outside  $\tilde{a}_i$ . The hypothesis that  $\tilde{a}_i$  is convex is necessary, for otherwise at a non convex switch any continuation of  $b_j$  along  $\mathcal{O}^s(y)$  would have to enter  $\tilde{a}_i$ . If one encounters a singular point in  $\mathcal{O}^s(y)$  (which could be  $y$  itself), then continue along the prong closest to  $b_{j+1}$ . This produces a slice  $c_j$  of  $\mathcal{O}^s(y)$  with  $b_j \subset c_j$ . There is a component  $V_j$  of  $\mathcal{O} - c_j$  containing  $\tilde{a}_i$ . Since we choose the prong closest to  $b_{j+1}$  then

$$\bigcap_{j=1}^n V_j = \tilde{a}_i$$

Since  $x$  is not in  $\tilde{a}_i$ , then there is at least one  $j$  with  $x$  not in  $V_j$  and so  $c_j$  separates  $x$  from  $\tilde{a}_i$ . Let  $z$  be this slice  $c_j$ . This proves the claim.

Using the claim then for each  $i$  produce such a slice and denote it by  $l_i$ . Let  $\tilde{l}_i$  be the component of  $\mathcal{O} - l_i$  containing  $\tilde{a}_i$ . Up to subsequence assume all the  $l_i$  are in (say)  $\mathcal{O}^s$ . Since  $A$  is a master sequence for  $p$ , we may also assume, by lemma 3.22, that all the  $l_i$  are disjoint from each other.

We now analyse what happens to the  $l_i$ . The first possibility is that the sequence  $(l_i)$  escapes compact sets in  $\mathcal{O}$ . Then this sequence defines an ideal point of  $\mathcal{O}$ . As  $\tilde{a}_i \subset \tilde{l}_i$ , it follows that  $L = (l_i)$  is an admissible sequence for  $p$  and  $A \leq L$ . Since  $A = (a_i)$  is a master sequence for  $p$ , then given  $\tilde{a}_i$ , there is  $j > i$  with  $l_j \cup \tilde{l}_j \subset \tilde{a}_i$  and so  $L \leq A$ . It follows that  $L = (l_i)$  is also a master sequence for  $p$ . This is case 1).

Suppose from now on that for any master sequence  $A = (a_i)$  for  $p$  and any  $(l_i)$  as constructed above, then  $(l_i)$  does not escape compact sets of  $\mathcal{O}$ . Then  $(l_i)$  converges to a family of non separated line leaves in  $\mathcal{O}^s$ :  $\mathcal{C} = \{c_k, k \in I \subset \mathbf{Z}\}$ . If there are no perfect fits then  $\mathcal{C}$  is a singleton by theorem 2.6. Assume  $\mathcal{C}$  is ordered as described in theorem 2.6. Here  $I$  is either  $\{1, \dots, k_0\}$  or is  $\mathbf{Z}$ .

Choose  $x_i \in b_i = a_i \cap l_i$ . These points will be used for the remainder of the proof. Since  $x_i$  is in  $a_i$  and  $(a_i)$  is a master sequence for  $p$ , the definition of the topology in  $\mathcal{D}$  (definition 3.15) implies that  $x$  converges to the fixed point  $p$  in  $\mathcal{D}$ . Here we need to differentiate between the set  $\mathcal{C}$  of leaves and the set  $\cup \mathcal{C}$  of points in the leaves in  $\mathcal{C}$ . For any  $y$  in  $\cup \mathcal{C}$ , then  $y \in c_k$  for some  $k$  and  $\mathcal{O}^u(y)$  intersects  $l_i$  for  $i$  big enough in a point denoted by  $y_i$ . Similarly for  $z$  in  $\cup \mathcal{C}$  define  $z_i = \mathcal{O}^u(z) \cap l_i$ . This notation will be used for the remainder of the proof.

Situation 1 – Suppose there are  $y, z \in \cup \mathcal{C}$  so that for big enough  $i$ ,  $x_i$  is between  $y_i$  and  $z_i$  in  $l_i$ .

We refer to fig. 14, a. Suppose that  $z$  is in  $c_{j_0}$ ,  $y$  in  $c_{j_1}$ , with  $j_0 \leq j_1$  in the given order of  $\mathcal{C}$ . If  $j_0 = j_1$  then the segment  $u_i$  of  $l_i$  between  $z_i, y_i$  converges to the segment in  $\mathcal{O}^s(z)$  between  $z$  and  $y$ . Then  $x_i$  does not escape compact sets, contradiction to  $A = (a_i)$  being an admissible sequence.

For any  $k$  the leaves  $c_k, c_{k+1}$  are non separated from each other and there is a leaf  $e$  of  $\mathcal{O}^u$  making perfect fits with both  $c_k$  and  $c_{k+1}$ . This defines an ideal point  $w$  of  $\partial \mathcal{O}$  which is an ideal point of equivalent rays of  $c_k, c_{k+1}$  and  $e$ , see fig. 14, a ( $k = j_0$  in the figure). Consider the open region  $D$  of  $\mathcal{O}$  bounded by the ray of  $c_{j_0}$  defined by  $z$  and going in the  $y$  direction, the segment in  $\mathcal{O}^u(z)$  from  $z$  to  $z_i$ , the segment  $u_i$  in  $l_i$  from  $z_i$  to  $y_i$ , the segment in  $\mathcal{O}^u(y)$  from  $y_i$  to  $y$ , the ray in  $\mathcal{O}^s(y)$  defined by  $y$  and going towards the  $z$  direction and the leaves  $c_k$  with  $j_0 < k < j_1$  (this last set is empty if and only if  $j_1 = j_0 + 1$ ). By the remark above, the only ideal points of  $D$  in  $\partial \mathcal{O}$ , that is the set  $\overline{D} \cap \partial \mathcal{O}$  (closure in  $\mathcal{D}$ ), are those associated to the appropriate rays of  $c_k$  with  $j_0 \leq k \leq j_1$ . Since  $(x_i)$  converges to  $p$  which is in  $\partial \mathcal{O}$ ,

then  $p$  is one of these points. So  $p$  is an ideal point of a ray of  $\mathcal{O}^s$  or  $\mathcal{O}^u$  which makes a perfect fit with another leaf. There is a master sequence which is a standard sequence associated to  $p$ . This is case 2 of the proposition.

**Situation 2** – For any  $y, z$  in  $\mathcal{UC}$  the  $x_i$  is eventually not between the corresponding  $y_i, z_i$ .

Let  $y \in \mathcal{UC}$ . Then up to subsequence the  $x_i$  are in one side of  $y_i$  in  $l_i$ , say in the side corresponding to increasing  $k$  in the order of  $\mathcal{C}$  (this is in fact true for any big  $i$  as  $x_i$  converges in  $\mathcal{D}$ ).

Suppose first that  $\mathcal{C}$  is an infinite collection of non separated leaves. Let  $w$  be the ideal point associated to the infinite collection  $\mathcal{C}$  and in the increasing direction of  $\mathcal{C}$  as in lemma 3.27. We follow the notation of lemma 3.27: let  $d_m = a_m \cup b_m$  and let  $D = (d_m)$  be a master sequence associated to  $w$  as described in lemma 3.27. Fix  $m$ . Then  $x_i$  is eventually in  $\tilde{d}_m$ . Therefore  $x_i$  converges to  $w$  and it follows that  $w = p$ . Here we are in case 3).

Finally suppose that  $\mathcal{C}$  is finite. Let  $w$  be the ideal point of the ray of  $c_{k_0}$  corresponding to the increasing direction in  $\mathcal{C}$ . Let  $y_n$  in  $c_{k_0}$  converging to  $w$ , see fig. 14, b. Let

$$y_n(i) = \mathcal{O}^u(y_n) \cap l_i$$

Fix  $n$ . Then eventually in  $i$ , the  $x_i$  is in the component of  $l_i - y_n(i)$  in the  $w$  side, see fig. 14, b. Consider a standard sequence defining  $w$  so that: it is arbitrary in the side of  $\mathcal{O} - c_{k_0}$  not containing  $x_i$  and in the other side we have an arc in  $\mathcal{O}^u(y_n)$  from  $y_n$  to  $y_n(i)$  and then a ray in  $l_i$  – which contains  $x_i$  for  $i$  big. Since  $c_{k_0}$  is the biggest element in  $\mathcal{C}$ , there is no leaf of  $\mathcal{O}^s$  non separated from  $c_{k_0}$  in that side of  $C_{k_0}$ . Hence the  $l_i$  cannot converge (in  $\mathcal{O}$ ) to anything on that side and those parts of  $l_i$  escape in  $\mathcal{O}$ . As the  $x_i$  are in these subarcs of  $l_i$  then  $x_i \rightarrow w$  in  $\mathcal{D}$  and so  $p = w$ .

Let  $r_n = \mathcal{O}^u(y_n)$ . If  $r_n$  escapes compact sets in  $\mathcal{O}$  as  $n \rightarrow \infty$ , then it defines a master sequence for  $p$  and we are in case 1). Otherwise  $r_n$  converges to some  $r$  making a perfect fit with  $c_{k_0}$  and we are in case 2). This finishes the proof of proposition 3.33.  $\square$

## 4 Flow ideal boundary and compactification of the universal cover

For the remainder of the article, unless otherwise stated, we will only consider pseudo-Anosov flows without perfect fits and not conjugate to suspension Anosov flows. In this section we compactify the universal cover  $\widetilde{M}$  with a sphere at infinity using only dynamical systems tools.

**Lemma 4.1.** (*model pre compactification*) *Let  $M$  be a closed 3-manifold with a pseudo-Anosov flow without perfect fits and not conjugate to suspension Anosov. There is a compactification  $\mathcal{D} \times [-1, 1]$  of  $\widetilde{M}$  which is a topological product.*

*Proof.* Recall that  $\mathcal{D}$  is a compactification of the orbit space  $\mathcal{O}$  of  $\widetilde{\Phi}$  and  $\mathcal{D}$  is homeomorphic to a closed disk. Consider  $\mathcal{D} \times [-1, 1]$  with the product topology. This is compact and homeomorphic to a closed 3-ball. The set  $\widetilde{M}$  is homeomorphic to the interior of  $\mathcal{D} \times [-1, 1]$  which is  $\mathcal{O} \times (-1, 1)$ . In fact choose a cross section  $f_1 : \mathcal{O} \rightarrow \widetilde{M}$  and a homeomorphism  $f_2 : (-1, 1) \rightarrow \mathbf{R}$ . This produces a homeomorphism

$$f : \mathcal{O} \times (-1, 1) \rightarrow \widetilde{M}, \quad f(x, t) = \widetilde{\Phi}_{f_2(t)}(f_1(t))$$

Clearly the topology in  $\widetilde{M}$  is the same as the induced topology from  $\mathcal{O} \times (-1, 1)$ . In this way  $\widetilde{M}$  can be seen as an open dense subset of  $\mathcal{D} \times [-1, 1]$  and  $\mathcal{D} \times [-1, 1]$  is a compactification of  $\widetilde{M}$ .  $\square$

This construction is reminiscent of the one done by Cannon-Thurston [Ca-Th] for fibrations. Notice that this construction works for any pseudo-Anosov flow, even with perfect fits.

**Important remark** – We should stress that this precompactification  $\mathcal{D} \times [-1, 1]$  is far from natural, because in general it is very hard to put a topology in  $\partial\mathcal{O} \times (-1, 1)$  which is group equivariant. In other words the section  $f_1 : \mathcal{O} \rightarrow \widetilde{M}$  is not natural at all. The interior of  $\mathcal{D} \times [-1, 1]$  is homeomorphic to  $\widetilde{M}$

and clearly  $\pi_1(M)$  acts on this open set. The topology in  $\mathcal{D} \times \{-1, 1\}$  is what you would expect, since it is homeomorphic to the topology of  $\mathcal{D}$ , which is group equivariant. But the topology in  $\partial\mathcal{O} \times [-1, 1]$  is really not well defined. Using the section  $f_1$  we can define a trivialization of  $\partial\mathcal{O} \times [-1, 1]$ , connecting it to  $\widetilde{M} \cong \mathcal{O} \times (-1, 1)$ . The problem here is that given a covering translation  $h$  of  $\widetilde{M}$ , there is no guarantee that it will extend continuously to  $\partial\mathcal{O} \times (-1, 1)$  (but it does extend naturally and continuously to  $\mathcal{D} \times \{-1, 1\}$ ). This problem is easily seen even in the case of suspension pseudo-Anosov flows. Instead of using the lift of a fiber as a section  $\mathcal{O} \rightarrow \widetilde{M}$ , use a section which goes one step lower (with respect to the fiber) in certain directions. From the point of view of the new trivialization of  $\mathcal{D} \times [-1, 1]$  certain covering translations will not extend to  $\mathcal{D} \times [-1, 1]$ .

But this will not be a problem for us, because we will collapse  $\partial\mathcal{D} \times [-1, 1]$ , identifying each vertical interval  $\{z\} \times [-1, 1]$  ( $z$  in  $\partial\mathcal{O}$ ) to a point. In fact one could have adjoined to  $\widetilde{M}$  just the top and bottom  $\mathcal{D} \times \{-1, 1\}$ . However it is much easier to describe sets and neighborhoods in the  $\mathcal{D} \times [-1, 1]$  model as above, making many arguments simpler. The topology of the quotient space will be completely independent of the chosen section/trivialization and will depend only on the pseudo-Anosov flow.

The compactification of  $\widetilde{M}$  we desire will be a quotient of  $\mathcal{D} \times [-1, 1]$ , where the identifications occur only in the boundary sphere. First we work only in the boundary of  $\mathcal{D} \times [-1, 1]$  and later incorporate  $\widetilde{M}$ .

We will use a theorem of Moore concerning cellular decompositions. A decomposition  $G$  of a space  $X$  is a collection of disjoint nonempty closed sets whose union is  $X$ . There is a quotient space  $X/G$  and a map  $\nu : X \rightarrow X/G$ . The points of  $X/G$  are just the elements of  $G$ . The point  $\nu(x)$  is the unique element of  $G$  containing  $x$ . The topology in  $X/G$  is the quotient topology: a subset  $U$  of  $X/G$  is open if and only if  $\nu^{-1}(U)$  is open in  $X$ .

A decomposition  $G$  of  $X$  satisfies the *upper semicontinuity property* provided that, given  $g$  in  $G$  and  $V$  open in  $X$  containing  $g$ , the union of those  $g'$  of  $G$  contained in  $V$  is an open set in  $X$ . Equivalently  $\nu$  is a closed map.

A decomposition  $G$  of a closed 2-manifold  $B$  is *cellular*, provided that  $G$  is upper semicontinuous and provided each  $g$  in  $G$  is compact and has a non separating embedding in the Euclidean plane  $E^2$ . The following result was proved by R. L. Moore for the case of a sphere:

**Theorem 4.2.** (*approximating cellular maps, Moore's theorem*) *Let  $G$  denote a cellular decomposition of a 2-manifold  $B$  homeomorphic to a sphere. Then the identification map  $\nu : X \rightarrow X/G$  can be approximated by homeomorphisms. In particular  $X$  and  $X/G$  are homeomorphic.*

**Theorem 4.3.** (*flow ideal boundary*) *Let  $\Phi$  be a pseudo-Anosov flow in  $M^3$  closed which is not topologically conjugate to a suspension Anosov flow and there are no perfect fits between leaves of  $\widetilde{\Lambda}^s, \widetilde{\Lambda}^u$ . Let  $\mathcal{D} \times [-1, 1]$  be the model pre compactification of  $\widetilde{M}$ . Then  $\partial(\mathcal{D} \times [-1, 1])$  has a quotient  $\mathcal{R}$  which is a 2-sphere where the group  $\pi_1(M)$  acts by homeomorphisms. The space  $\mathcal{R}$  and its topology are completely independent of the model precompactification  $\mathcal{D} \times [-1, 1]$  and depend only on the flow  $\Phi$ .*

*Proof.* The topology in  $\mathcal{D} \times \{-1, 1\}$  is well defined by the obvious bijections  $\mathcal{D} \rightarrow \mathcal{D} \times \{1\}$ ,  $\mathcal{D} \rightarrow \mathcal{D} \times \{-1\}$ . The structure of  $\mathcal{O}^s \times \{1\}$  in  $\mathcal{D} \times \{1\}$  is then equivalent to that of  $\mathcal{O}^s$  in  $\mathcal{D}$ , etc.. We will stress where needed that arguments are independent of parametrization/trivialization of  $\partial\mathcal{O} \times (-1, 1)$ .

We construct a cellular decomposition  $\mathcal{R}$  of  $\partial\mathcal{D} \times [-1, 1]$  as follows. The cells are one of the following types:

- (1) Let  $l$  be a leaf of  $\mathcal{O}^s$  with ideal points  $a_1, \dots, a_n$  in  $\partial\mathcal{O}$ . Consider the cell element

$$g_l = l \times \{1\} \cup \bigcup_{1 \leq i \leq n} a_i \times [-1, 1]$$

- (2) Let  $l$  be a leaf of  $\mathcal{O}^u$  with ideal points  $b_1, \dots, b_m$  in  $\partial\mathcal{O}$ . Consider the cell element

$$g_l = l \times \{-1\} \cup \bigcup_{1 \leq i \leq m} b_i \times [-1, 1]$$

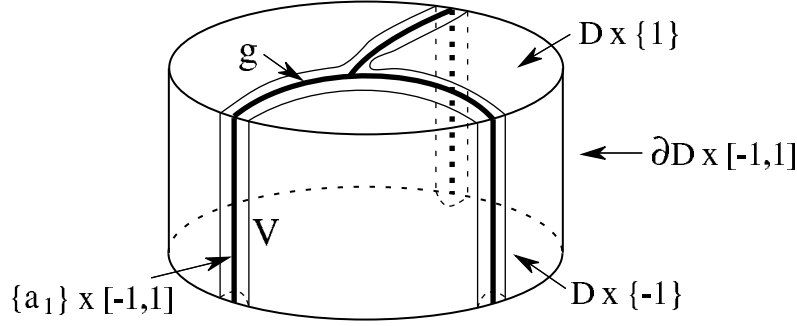

Figure 15: An element of  $g$  type (1) in  $\partial\mathcal{D} \times [-1, 1]$  and a neighborhood of it.

(3) Let  $z$  be a point of  $\partial\mathcal{O}$  which is not an ideal point of a ray of  $\mathcal{O}^s$  or  $\mathcal{O}^u$ . Consider the cell element  $g_z = z \times [-1, 1]$ .

Later on we will think of  $\mathcal{R}$  as a set of points with the quotient topology induced by the map from  $\partial(\mathcal{D} \times [-1, 1])$  to  $\mathcal{R}$ .

Since every point in  $\mathcal{O}$  is in a leaf of  $\mathcal{O}^s$ , then elements of type (1) cover  $\mathcal{O} \times \{1\}$ . Similarly elements of type (2) cover  $\mathcal{O} \times \{-1\}$ . Finally elements of type (3) cover the rest of  $\partial\mathcal{O} \times [-1, 1]$ . Cover here means the union contains the set in question. Under the hypothesis of no perfect fits, no two rays of  $\mathcal{O}^s$  or  $\mathcal{O}^u$  have the same ideal point. This implies that distinct elements of type (1), (2) or (3) are disjoint from each other. This defines the decomposition  $\mathcal{R}$  of  $\partial(\mathcal{D} \times [-1, 1])$ .

We now show that  $\mathcal{R}$  is a cellular decomposition of  $\partial(\mathcal{D} \times [-1, 1])$ . Any element of type (3) is homeomorphic to a closed interval, hence compact. An element  $g$  of type (1) is the union of finitely many closed intervals in  $\partial\mathcal{O} \times [-1, 1]$  and a set  $(l \cup \partial_\infty l) \times \{1\}$  in  $\mathcal{D} \times \{1\}$ . The set  $l \cup \partial_\infty l$  (contained in  $\mathcal{D}$ ) is homeomorphic to a compact  $k$ -prong in the plane. Therefore  $g$  is compact and homeomorphic to  $l \cup \partial_\infty l$ . In addition, any  $g$  in  $\mathcal{R}$  has a non separating embedding in the Euclidean plane.

Next we prove that  $\mathcal{R}$  is upper semicontinuous. Let  $g$  in  $\mathcal{R}$  and  $V$  an open set in  $\partial(\mathcal{D} \times [-1, 1])$  containing  $g$ . Let  $V'$  be the union of the  $g'$  in  $\mathcal{R}$  with  $g' \subset V$ . We need to show that  $V'$  is open in  $\partial(\mathcal{D} \times [-1, 1])$ . Since  $g$  is arbitrary it suffices to show that  $V'$  contains an open neighborhood of  $g$  in  $\partial(\mathcal{D} \times [-1, 1])$ . We do the proof for elements of type (1) see fig. 15, the other cases being very similar.

Let  $g$  be generated by the leaf  $l$  of  $\mathcal{O}^s$ , let  $a_1, \dots, a_n$  be the ideal points of  $l$  in  $\partial\mathcal{O}$ . For each  $i$  there is a neighborhood  $J_i$  of  $a_i$  in  $\partial\mathcal{O}$  with  $J_i \times [-1, 1]$  contained in  $V$ . This is because  $\partial\mathcal{O} \times [-1, 1]$  is homeomorphic to a closed annulus. This conclusion is independent of the parametrization we choose for  $\partial\mathcal{O} \times [-1, 1]$ .

Let  $(p_k)_{k \in \mathbb{N}}$  be a sequence of points in  $\partial(\mathcal{D} \times [-1, 1])$  converging to some point  $p$  in  $g$ . Let  $g_k$  be the element of  $\mathcal{R}$  containing  $p_k$ . We show that for  $k$  big enough, then  $g_k$  is contained in  $V$  and therefore  $p_k$  has to be contained in  $V'$ . Hence  $V'$  contains an open neighborhood of  $g$  in  $\partial\mathcal{D} \times [-1, 1]$ . This will prove the upper semicontinuity property of the cellular decomposition.

Up to a subsequence we may assume that all  $p_k$  are either in I)  $\mathcal{O} \times \{1\}$ , II)  $\mathcal{O} \times \{-1\}$  or III)  $\partial\mathcal{O} \times [-1, 1]$ . We analyse each case separately:

Case I – Suppose first that  $p_k$  is in  $\mathcal{O} \times \{1\}$ .

Hence  $p_k \in \mathcal{D} \times \{1\}$ . Up to subsequence and reordering  $\{a_i\}$ , assume that  $p_k$  are in a sector of  $l \times \{1\}$  defined by  $b \times \{1\}$  where  $b$  is a line leaf of  $l$  with ideal points  $a_1, a_2$ . Then  $g_k$  is an element of type (1) and is the union

$$g_k = l_k \times \{1\} \cup \cup_j (\{w_{kj}\} \times [-1, 1])$$

where  $w_{kj}, 1 \leq j \leq j_0$  are the ideal points of  $l_k$ , a leaf of  $\mathcal{O}^s$ . Notice that  $g_k$  is contained in the set  $(\mathcal{D} \times \{1\}) \cup (\partial\mathcal{O} \times [-1, 1])$ .

We need the following result which is also useful later. It shows the strength of the no perfect fits hypothesis.



**Lemma 4.4.** *(the escape lemma) Let  $\Phi$  be a pseudo-Anosov without perfect fits and not conjugate to a suspension Anosov flow.*

i) *Let  $(l_n)_{n \in \mathbb{N}}$  be a sequence of leaves or slices of leaves of (say)  $\mathcal{O}^s$ . Suppose that  $(l_n)$  converges to a line leaf  $l$  of (say)  $\mathcal{O}^s$ . It follows that the ideal points of  $l_n$  converge to the ideal points of  $l$ ,*

ii) *Under the hypothesis of i), if  $x_{n_k} \in l_{n_k}$  converges to  $x$  in  $\mathcal{D}$ , then  $x$  is in  $l \cup \partial l$ .*

iii) *Let  $l_n$  in  $\mathcal{O}^s$  or  $\mathcal{O}^u$ . Suppose there are  $x_n, y_n$  in  $l_n \cup \partial l_n$  so that  $x_n, y_n$  converge to distinct points of  $\partial \mathcal{O}$ . Then  $l_n$  converges to a leaf  $l$ . In particular  $l_n$  does not escape compact sets in  $\mathcal{O}$ .*

*Proof.* Suppose i) is not true. Let  $p$  in  $l$ . Hence there is an ideal point  $a_1$  of  $l$  in  $\partial \mathcal{O}$  and there are  $r_n$  rays of  $l_n$  starting at  $p_n$  and in the direction of the ray in  $l$  with ideal point  $a_1$  so that:  $b_n = \partial r_n$  does not converge to  $a_1$ . This also works up to subsequences. We may assume that  $(l_n)$  is nested. By separation properties  $b_n$  is weakly monotone in  $\partial \mathcal{O}$  and converges to a point  $c \neq a_1$ . Consider the interval  $(c, a_1)$  of  $\partial \mathcal{O}$  not containing  $a_2$ . Suppose first that this interval has an ideal point of a leaf  $e$  of  $\mathcal{O}^s$  or  $\mathcal{O}^u$ . The leaf  $e$  is a barrier for the leaves  $l_n$ , so this implies that  $l_n$  also converges to another leaf besides  $l$ . Since there are no perfect fits, this is impossible by theorem 2.6. We are left with the possibility that  $(c, a_1)$  does not have an ideal point of a leaf of  $\mathcal{O}^s$  or  $\mathcal{O}^u$ . But this is also impossible: let  $z$  in  $(c, a_1)$ . If  $z$  is ideal point of leaf of  $\mathcal{O}^s$  or  $\mathcal{O}^u$  we are done. Since there are no perfect fits, option 1) of proposition 3.33 has to occur and there is a neighborhood system of  $z$  defined by a sequence of stable leaves. This shows that any neighborhood of  $z$  in  $\partial \mathcal{O}$  has points which are ideal points of leaves of  $\mathcal{O}^s$ . These arguments show that these ideal points of  $l_n$  converge to  $a_1$ . This proves i).

Proof of ii). Up to taking a subsequence we assume the statement is for  $x_n$  in  $l_n$ . Since the leaf space of  $\mathcal{O}^s$  is Hausdorff, if  $x$  is in  $\mathcal{O}$  then  $x$  is in  $l$ . Suppose that  $x$  is in  $\partial \mathcal{O}$ . Using the notation from part i) suppose that  $x_n$  are in the rays  $r_n$  as in part i). Suppose that  $x_n$  does not converge to  $a_1$  and instead converges to  $c \neq a_1$ . Let  $U, V$  small disjoint neighborhoods of  $a_1, c$ . By conclusion i) already proved, for  $n$  big  $r_n$  has ideal point in  $U$ . Fix one such  $n$  and so  $r_n$  is entirely in  $U$  except for an initial compact segment  $t$ . For any  $m > n$  the  $r_m$  is constricted to be in the union of two sets  $S_1$  and  $S_2$ : 1)  $S_1$  the compact region of  $\mathcal{O}$  which is bounded by a polygon made of 4 arcs: A)  $t$ , B) a compact arc  $l'$  in  $l$  from  $p$  to a point in  $U$ , C) a compact arc in  $U$  from the the end of  $l'$  to the end of  $t$  and D) a very small arc from the beginning of  $t$  to the beginning of  $l$ ; 2) the second set  $S_2 = U$ . Since  $(x_m)$  escapes compact sets in  $\mathcal{O}$ , then for big  $m$ ,  $x_m$  cannot be in  $S_1$  so it has to be in  $S_2 = U$ , contradiction to  $x_m \in V$ . This shows that  $x_i$  converges to  $a_1$ .

Proof of iii). Wlog assume that  $l_n$  are leaves of  $\mathcal{O}^s$ . Let  $x_n, y_n$  converging to distinct points  $x, y$  of  $\partial \mathcal{O}$ . If  $x_n$  is in  $\partial \mathcal{O}$  one can choose a point in  $l_n$  arbitrarily near  $x_n$ , so we may assume that all  $x_n, y_n$  are in  $\mathcal{O}$ . Let  $r_n$  be the arc in  $l_n$  from  $x_n$  to  $y_n$ . If the sequence  $(r_n)$  escapes compact sets in  $\mathcal{O}$ , then it limits on at least one of the intervals  $(x, y)$  or  $(y, x)$  both of which are non degenerate. But that would imply that this interval does not contain an ideal point of a ray of  $\mathcal{O}^s$  or  $\mathcal{O}^u$  – this was proved to be impossible in the proof of part i). Since  $l_n$  does not escape compact sets in  $\mathcal{O}$ , there is a subsequence  $(l_{n_k})$  and  $p_{n_k}$  in  $l_{n_k}$  with  $p_{n_k}$  converging to a point  $p$  in  $\mathcal{O}$ . Let  $l$  be the leaf of  $\mathcal{O}^s$ , with  $p \in l$ . Hence the sequence  $(l_{n_k})$  converges to  $l$  (and to no other leaf when there are no perfect fits). Since  $x_{n_k}$  is in  $l_{n_k}$  and converges to  $x$ , part ii) shows that  $x$  is an ideal point of  $l$  and so is  $y$ . Notice in addition that in the case of no perfect fits there is only one leaf of  $\mathcal{O}^s$  with ideal point  $x$ . But these arguments can be applied to any subsequence of  $(l_n)$  to show that such a subsequence has another subsequence converging to a leaf  $l'$  which has an ideal point  $x$ . But as remarked before this implies that  $l = l'$ . It follows that the original sequence  $(l_n)$  has to converge to  $l$ . This finishes the proof of iii).  $\square$

Notice that conclusion iii) is false for suspension Anosov flows.

#### Continuation of the proof of theorem 4.3

Recall the setup in case I:  $p_k \in \mathcal{O} \times \{1\}$  converge to  $p$  in  $g = g_l$ . The  $p_k$  are in  $l_k \times \{1\}$  with  $l_k$  all in a sector of  $b$  line leaf of  $l$  with ideal points  $a_1, a_2$ ;  $V$  is a neighborhood of  $g$  in  $\partial(\mathcal{D} \times [-1, 1])$ . Let  $p_k = y_k \times \{1\}$ .

Case I.1 – Suppose  $p \in \mathcal{O} \times \{1\}$ .

Then  $p_k$  converges to  $p = y \times \{1\}$ . By lemma 4.4 part ii) any limit point of  $x_{n_k}$  with  $x_{n_k}$  in  $l_{n_k}$  is in  $b \cup \{a_1, a_2\}$ . Hence  $l_n \times \{1\} \subset V$  for  $n$  big. Lemma 4.4 part i), the ideal points of rays in  $l_k$  also converge to  $a_1$  or  $a_2$  and so  $w_{kj} \times [-1, 1] \subset V$  for  $k$  big. It follows that  $g_k \subset V$  for  $k$  big in this case.

Case I.2 – Suppose  $p \in \partial\mathcal{O} \times \{1\}$ .

Wlog assume that  $p$  is  $a_1 \times \{1\}$ . In this case suppose first that  $(l_k)$  does not escape compact sets in  $\mathcal{O}$ . Assume up to subsequence that  $(l_k)$  converges to a line leaf  $s$  of  $\mathcal{O}^s$ . Then we may assume that  $l_k$  is nested. Since there are no perfect fits, there is only one such leaf  $s$  in the limit. As  $p_k \in l_k \times \{1\}$ , lemma 4.4 part ii) shows that the limit of  $y_k$  is an ideal point of a ray of  $s$ . This limit is  $a_1$  so  $a_1$  is an ideal point of  $s$ . This shows that  $s, l$  have rays with same ideal points. By definition the rays are equivalent. But since there are no perfect fits, then  $s = l$ . This reduces the proof to case I.1.

Finally we suppose that  $(l_k)$  escapes compact sets in  $\mathcal{O}$ . Since there are  $p_k$  in  $l_k \times \{1\}$  converging to  $a_1 \times \{1\}$  we claim that  $g_k \cap (\mathcal{D} \times \{1\})$  converges to  $a_1 \times \{1\}$ . Otherwise up to subsequence there are  $z_k$  in  $l_k$  with  $z_k$  converging to  $v \neq a_1$ . Hence  $l_k$  has arcs with endpoints in  $y_k \rightarrow a_1$  and  $z_k \rightarrow v$ . The escape lemma (lemma 4.4 part i) implies that  $l_k$  does not escape compact sets in  $\mathcal{O}$ , contradiction. This finishes the analysis of case I).

The next case in the proof of theorem 4.3 is:

Case II – Suppose that  $p_k$  is in  $\mathcal{O} \times \{-1\}$ .

There is an asymmetry here because in case I,  $g$  and  $g_k$  are cells to type (1), whereas in case II,  $g$  is of type (1) and  $g_k$  is of type (2). So we cannot just revert the direction of the flow and use the proof of case I to prove case II.

In this case it follows that  $g_k$  is contained in  $(\mathcal{D} \times \{-1\}) \cup (\partial\mathcal{O} \times [-1, 1])$ . Since  $p_k$  converges to  $p$  in  $g$  and  $g$  is contained in  $(\mathcal{D} \times \{1\}) \cup (\partial\mathcal{O} \times [-1, 1])$ , it follows that  $p$  is in  $\partial\mathcal{O} \times \{-1\}$  and  $p$  is say  $(a_1, -1)$ , where  $a_1$  is one of the ideal points of  $l$ .

Here  $a_1$  is an ideal point of a ray in  $\mathcal{O}^s$  and there are no perfect fits and no non separated leaves of  $\mathcal{O}^s$  or  $\mathcal{O}^u$ . Therefore proposition 3.33 shows that there is a neighborhood system of  $a_1$  in  $\mathcal{D}$  defined by a sequence  $(r_n)_{n \in \mathbb{N}}$  of unstable leaves (this is option (1) in proposition 3.33). Since  $V$  is open in  $\partial(\mathcal{D} \times [-1, 1])$ , then for  $n$  big enough  $r_n \times \{-1\}$  is contained in  $V$ . The element  $g_k$  is of the form

$$(s_k \times \{-1\}) \cup \cup_j (\{b_{kj}\} \times [-1, 1])$$

where the  $s_k$  are leaves of  $\mathcal{O}^u$  with points converging to  $a_1$ . Since both  $r_n$  and  $s_k$  are unstable leaves, they cannot intersect transversely. It now follows that for  $k$  big enough  $s_k \times \{-1\}$  is contained in  $V$ . There is an interval  $J$  in  $\partial\mathcal{O}$  with  $a_1$  in the interior of  $J$  and with  $J \times [-1, 1] \subset V$  – this is because  $V$  is open and  $a_1 \times [-1, 1]$  is contained in  $V$ . Hence the endpoints  $b_j$  have to be in  $J$  for  $k$  big enough. It follows that  $g_k$  is entirely contained in  $V$ . This finishes the analysis of case II.

Case III – Suppose that  $p_k$  is in  $\partial\mathcal{O} \times [-1, 1]$ .

Then  $p_k$  converges to  $p = (c, t)$  where  $c$  is in  $\partial\mathcal{O}$ . Hence  $V$  contains  $J \times [-1, 1]$  for some interval  $J$  in  $\partial\mathcal{O}$ , so that  $J$  contains  $c$  in its interior. Here  $g_k$  can be type (1), (2) or (3). If  $g_k$  is of type (3) then for  $k$  big enough the  $g_k$  is contained in  $J \times [-1, 1]$  and hence in  $V$ .

If  $g_k$  is of type (2), then it has vertical stalks  $b_{kj} \times [-1, 1]$  which are eventually contained in  $J \times [-1, 1]$ . Hence  $b_{kj}$  is an ideal point of a leaf  $s_k$  in  $\mathcal{O}^u$ . As  $k$  varies, one of the ideal points of  $s_k$  (namely  $b_{kj}$ ) converges to  $a_1$ , which is an ideal point of  $l$ . The proof then proceeds as in case II to show that eventually  $g_k$  is entirely contained in  $V$ .

Finally if  $g_k$  is of type (1), then as seen in part I),  $g_k$  is contained in  $V$  for  $k$  big enough.

This proves that  $V'$  is open. We conclude that the decomposition satisfies the upper semicontinuity property. By Moore's theorem it follows that  $\mathcal{R}$  is a sphere.

So far we have not really used the topology in  $\partial\mathcal{O} \times [-1, 1]$ . We still need to show that the topology of  $\mathcal{R}$  is independent of the choice of the trivialization  $\partial\mathcal{O} \times [-1, 1]$  and that the fundamental group acts

naturally by homeomorphisms on  $\mathcal{R}$ .

To see the first statement, notice that the quotient map  $\partial\mathcal{D} \times [-1, 1] = \partial(\mathcal{D} \times [-1, 1]) \rightarrow \mathcal{R}$  can be done in two steps: first collapse each vertical stalk  $\{z\} \times [-1, 1]$  to a point where  $z$  is in  $\partial\mathcal{O}$  and then do the remaining collapsing of leaves of  $\mathcal{O}^u$  in  $\mathcal{D} \times \{-1\}$  and leaves of  $\mathcal{O}^s$  in  $\mathcal{D} \times \{1\}$ . After the first collapsing we have  $\mathcal{D} \times \{1\}$  union  $\mathcal{D} \times \{-1\}$  glued along the points  $\{w\} \times \{-1, 1\}$ . The topology now is completely determined since the topology on the top  $\mathcal{D} \times \{1\}$  and the bottom  $\mathcal{D} \times \{-1\}$  is completely determined by the topology in  $\mathcal{D}$ . The fundamental group acts by homeomorphisms in this object and preserves the foliations stable on the top and unstable on the bottom. Therefore the second collapse produces a sphere  $\mathcal{R} = \partial\mathcal{D} \times [-1, 1]/\mathcal{R}$ . The topology in  $\mathcal{R}$  is independent of any choices. The fundamental group acts by homeomorphisms on the quotient space  $\mathcal{R}$ , since after the first collapse it acts by homeomorphisms and preserves the elements of the decomposition. This finishes the proof of the theorem 4.3.  $\square$

We now show that the action of  $\pi_1(M)$  in  $\mathcal{R}$  has excellent properties, that is, it is a uniform convergence group action. A topological space  $X$  is a *compactum* if it is a compact Hausdorff topological space. Let  $X$  be a compactum and  $\Gamma$  a group acting by homeomorphisms on  $X$ . Let  $\Theta_3(X)$  be the space of distinct triples of  $X$  with the subspace topology the product space  $X \times X \times X$ . Then  $\Theta_3(X)$  is locally compact and there is an induced action of  $\Gamma$  on  $\Theta_3(X)$ . Here *local uniform convergence* means uniform convergence in compact sets. For simplicity we state results for  $X$  metrisable (in the general case one uses nets instead of sequences [Bo2]). Notice we identify the group with the action.

**Definition 4.5.** (*[Ge-Ma]*)  $\Gamma$  is a convergence group if the following holds: If  $(\gamma_i)_{i \in \mathbb{N}}$  is an infinite sequence of distinct elements of  $\Gamma$ , then one can find points  $a, b$  in  $X$  and a subsequence  $(\gamma_{i_k})_{k \in \mathbb{N}}$  of  $(\gamma_i)$ , such that the maps  $\gamma_{i_k}|_{X - \{a\}}$  converge locally uniformly to the constant map with value  $b$ .

Notice that it is not necessary that  $a, b$  are distinct, which in fact does not happen always. It is simple to see that this is equivalent to the following property: the action of  $\Gamma$  on  $\Theta_3(X)$  is *properly discontinuous* [Tu2, Bo2]. This means that for any compact subset  $K$  of  $\Theta_3(X)$ , the set  $\{\gamma \in \Gamma \mid \gamma K \cap K \neq \emptyset\}$  is finite [Tu2, Bo2]. The action of  $\Gamma$  is *cocompact* if  $\Theta_3(X)/\Gamma$  is a compact space. If the action is a convergence group and cocompact it is called an *uniform convergence group action*.

**Definition 4.6.** (*conical limit points*) Let  $\Gamma$  be a group action on a metrisable compactum  $X$ . A point  $z$  in  $X$  is a conical limit point for the action of  $\Gamma$  if there are distinct points  $a, b$  of  $X$  and a sequence  $(\gamma_i)_{i \in \mathbb{N}}$  in  $\Gamma$  such that  $\gamma_i z \rightarrow a$  and  $\gamma_i y \rightarrow b$  for all  $y$  in  $X - \{z\}$ .

Here it is crucial that  $a, b$  are distinct for otherwise the convergence group property would yield the result for many points. Basic references for conical limit points are [Tu3, Bo2]. It is a simple result that if  $\Gamma$  is a uniform convergence group action then every point of  $X$  is a conical limit point [Tu3, Bo2]. The opposite implication is highly non trivial and was proved independently by Tukia [Tu3] and Bowditch [Bo1]. Recall that  $X$  is perfect if it has no isolated points.

**Theorem 4.7.** (*[Tu3, Bo1]*) Suppose that  $X$  is a perfect, metrisable compactum and that  $\Gamma$  is a convergence group action on  $X$ . If every point of  $X$  is a conical limit point for the action, then  $\Gamma$  is a cocompact action. Consequently  $\Gamma$  is a uniform convergence group action.

Hence both properties of uniform convergence group action can be checked by analysing sequences of elements of  $\Gamma$ . Our main technical result is the following:

**Theorem 4.8.** Let  $\Phi$  be a pseudo-Anosov flow in  $M^3$  closed so that  $\Phi$  does not have perfect fits and is not topologically conjugate to a suspension Anosov flow. Consider the induced quotient  $\mathcal{R}$  of  $\partial(\mathcal{D} \times [-1, 1])$  and the induced action of  $\Gamma = \pi_1(M)$  on  $\mathcal{R}$ . Then  $\Gamma$  is a uniform convergence group.

We first prove that  $\pi_1(M)$  acts as a convergence group on  $\mathcal{R}$  using the sequences formulation and then we show that every point of  $\mathcal{R}$  is a conical limit point for the action of  $\Gamma$  on  $\mathcal{R}$ . The space  $\mathcal{R}$  is homeomorphic to a sphere, hence it is a perfect, metrisable compact space and theorem 4.7 can be used.

First we define an important map which will be used throughout the proofs in this section. Recall there is a continuous quotient map  $\nu : \partial(\mathcal{D} \times [-1, 1]) \rightarrow \mathcal{R}$ . Identify  $\partial\mathcal{O}$  with  $\partial\mathcal{O} \times \{1\}$  by  $z \rightarrow (z, 1)$  in  $\partial(\mathcal{D} \times [-1, 1])$ . Then there is an induced map:

$$\varphi : \partial\mathcal{O} \rightarrow \mathcal{R}, \quad \varphi(z) = \nu((z, 1)) \quad (*)$$

The map  $\varphi$  is continuous. Every  $g$  of  $\mathcal{R}$  contains intervals of the form  $\{y\} \times [-1, 1]$  where  $y \in \partial\mathcal{O}$ , so  $\varphi$  is surjective. Hence  $\varphi$  encodes all of the information of the map  $\nu$ . In addition  $\pi_1(M)$  acts on  $\partial\mathcal{O}$ . The proof will use deep knowledge about the action of  $\Gamma = \pi_1(M)$  on the circle  $\mathbf{S}^1 = \partial\mathcal{O}$  in order to obtain information about the action of  $\Gamma$  on  $\mathcal{R}$ .

Notice that the map  $\varphi$  is group equivariant producing examples of group invariant sphere filling curves.

**Remarks** – 1) A very important fact is the following. Suppose that  $x, y$  distinct in  $\partial\mathcal{O}$  are identified under  $\varphi$ , that is  $\varphi(x) = \varphi(y)$ . Because of the no perfect fits condition, there are no distinct leaves of  $\mathcal{O}^s, \mathcal{O}^u$  sharing an ideal point in  $\partial\mathcal{O}$ . This implies there is a leaf  $l$  of  $\mathcal{O}^s$  or  $\mathcal{O}^u$  so that  $x, y$  are ideal points of  $l$ . In particular there are at most  $k$  preimages under  $\varphi$  of any point, where  $k$  is the maximum number of prongs at a singular point of  $\mathcal{O}^s$  or  $\mathcal{O}^u$ .

2) (important convention) Recall that  $\mathcal{H}^s, \mathcal{H}^u$  are the leaf spaces of  $\tilde{\Lambda}^s, \tilde{\Lambda}^u$  respectively. If  $\gamma$  is an element of  $\pi_1(M)$  then  $\gamma$  acts as a homeomorphism in all of the spaces  $\tilde{M}, \mathcal{O}, \partial\mathcal{O}, \mathcal{R}, \mathcal{H}^s$  and  $\mathcal{H}^u$ . For simplicity, the same notation  $\gamma$  will be used for all of these homeomorphisms. The context will make it clear which case is in question. With this understanding, the fact that  $\varphi$  is group equivariant means that for any  $\gamma$  in  $\pi_1(M)$  then

$$\gamma \circ \varphi = \varphi \circ \gamma$$

where the first  $\gamma$  acts on  $\mathcal{R}$  and the second acts on  $\partial\mathcal{O}$ . The reader should be aware that this convention will be used throughout this section.

Recall that if  $l$  is a ray or leaf of  $\mathcal{O}^s$  or  $\mathcal{O}^u$ , then  $\partial l$  denotes the ideal point(s) of  $l$  in  $\partial\mathcal{O}$ . Before proving theorem 4.8, we first show in the next 2 lemmas that for any  $\gamma$  in  $\pi_1(M)$ , the action of  $\gamma$  on  $\partial\mathcal{O}$  and  $\mathcal{R}$  is as expected. In the first lemma we do not assume that there are no perfect fits.

**Lemma 4.9.** *Suppose that  $\Phi$  is pseudo-Anosov flow not conjugate to suspension Anosov. Suppose there is no infinite collection of leaves of  $\tilde{\Lambda}^s$  or  $\tilde{\Lambda}^u$  which are all non separated from each other. Let  $\gamma$  in  $\pi_1(M)$  with no fixed points in  $\mathcal{O}$ . Then the action of  $\gamma$  on  $\partial\mathcal{O}$  either 1) has only 2 fixed points one attracting and one repelling and is of hyperbolic type or 2) it has a single fixed point in  $\partial\mathcal{O}$ , which is of parabolic type. In the second case, the fixed point of  $\gamma$  is a parabolic point in  $\partial\mathcal{O}$  associated to a perfect fit horoball. Finally if there are no perfect fits only option 1) can occur.*

*Proof.* If  $\gamma$  leaves invariant a leaf  $F$  in  $\mathcal{H}^s$ , then there is an orbit  $\tilde{\alpha}$  in  $F$  with  $\gamma(\tilde{\alpha}) = \tilde{\alpha}$ . Then  $\gamma$  does not act freely on  $\mathcal{O}$ , contradiction.

The space  $\mathcal{H}^s$  is what is called a non Hausdorff tree [Fe6, Ro-St]. Very roughly a non Hausdorff tree is a “one-dimensional” space with a tree like behavior, except that one allows non Hausdorff behavior. It is simply connected and is the union of countably many “segments”. Since  $\gamma$  acts freely on  $\mathcal{H}^s$  then theorem A of [Fe6] implies that  $\gamma$  has a translation axis for its action in  $\mathcal{H}^s$ . The transformation  $g$  leaves invariant this axis and acts as a translation on it. The points in the axis are exactly those leaves  $L$  of  $\tilde{\Lambda}^s$  so that  $\gamma(L)$  separates  $L$  from  $\gamma^2(L)$ . This implies that the  $\{\gamma^n(L), n \in \mathbf{Z}\}$  form a nested collection of leaves.

As explained in [Fe6], the axis does not have to be properly embedded in  $\mathcal{H}^s$  – that is there may be  $a_n$  in the axis, escaping in the axis, but not escaping compact sets in the leaf space  $\mathcal{H}^s$ . Let  $L$  be in the axis. If  $(\gamma^n(L))_{n \in \mathbf{N}}$  does not escape compact sets in  $\mathcal{O}$ , then by the nested property, the  $\gamma^n(L)$  converges to some  $F$  in  $\tilde{\Lambda}^s$  as  $n$  converges to infinity. If  $\gamma(F) = F$  we have an invariant leaf in  $\tilde{\Lambda}^s$ , contradiction. If  $\gamma(F), F$  are distinct let  $\mathcal{B}$  be the set of leaves of  $\tilde{\Lambda}^s$  non separated from  $F$  in the side the  $\gamma^n(L)$  are

limiting to. By theorem 2.6, the set  $\mathcal{B}$  is order isomorphic to either  $\mathbf{Z}$  or  $\{1, \dots, j\}$  for some  $j$ . The first option is disallowed by hypothesis. Consider the second option. The transformation  $\gamma$  leaves  $\mathcal{B}$  invariant. If  $\gamma$  preserves the order in  $\mathcal{B}$  then as  $\mathcal{B}$  is finite,  $\gamma$  will have invariant leaves in  $\tilde{\Lambda}^s$ , contradiction. If  $\gamma$  reverses order in  $\mathcal{B}$ , then there are consecutive elements  $F_0, F_1$  in  $\mathcal{B}$  which are swapped by  $\gamma$ . There is a unique unstable leaf  $E$  which separates  $F_0$  from  $F_1$ . This  $E$  makes a perfect fit with both  $F_0$  and  $F_1$ , see theorem 2.6. By the above this leaf  $E$  is invariant under  $\gamma$  again leading to a contradiction. This argument shows that the axis of  $\gamma$  is properly embedded in  $\mathcal{H}^s$ .

Let  $L_0$  be in the axis of  $\gamma$  acting on  $\mathcal{H}^s$ . As  $\gamma(L_0)$  separates  $L_0$  from  $\gamma^2(L_0)$ , there is a unique line leaf  $L$  of  $L_0$  so that the sector defined by  $L$  contains  $\gamma(L_0)$  (if  $L_0$  is nonsingular then  $L = L_0$ ). Recall that  $\Theta : \tilde{M} \rightarrow \mathcal{O}$  is the projection map: it sends a point  $x$  in  $\tilde{M}$  to the orbit of  $\tilde{\Phi}$  containing  $x$ . Then  $(\gamma^n(\Theta(L)))_{n \in \mathbf{N}}$  is a nested sequence of convex polygonal paths, which escapes in  $\mathcal{O}$ . Hence this sequence defines a unique ideal point  $b$  in  $\partial\mathcal{O}$ . Similarly  $(\gamma^{-n}(\Theta(L)))_{n \in \mathbf{N}}$  defines an ideal point  $a$  in  $\partial\mathcal{O}$ . Notice that

$$\gamma^n(\partial\Theta(L)) \rightarrow b \text{ as } n \rightarrow \infty \quad \text{and} \quad \gamma^n(\partial\Theta(L)) \rightarrow a \text{ as } n \rightarrow -\infty \quad (**)$$

Clearly  $\gamma(a) = a$ ,  $\gamma(b) = b$ . For any other  $z$  in  $\partial\mathcal{O}$ , then either  $z$  is an ideal point of some  $\gamma^n(\Theta(L))$  or  $z$  is in an interval of  $\partial\mathcal{O}$  defined by ideal points of  $\gamma^n(\Theta(L))$  and  $\gamma^{n+1}(\Theta(L))$  for some  $n$  in  $\mathbf{Z}$ . It follows that property  $(**)$  above also holds for  $z$ .

If  $a, b$  are distinct then the above shows that  $a, b$  form a source/sink pair for  $\gamma$  and  $\gamma$  has hyperbolic dynamics in the circle  $\partial\mathcal{O}$ .

If  $a = b$  then  $\gamma$  has parabolic dynamics in  $\partial\mathcal{O}$  with  $a$  its unique fixed point. In addition  $\Theta(L)$  has a ray  $l$  with ideal point  $a$ . The collection  $\{\gamma^n(l)\}_{n \in \mathbf{Z}}$  of pairwise distinct rays all have ideal point  $a$ . By lemma 3.20 any two elements in this collection are connected by a chain of perfect fits. Then  $\{\gamma^n(l)\}_{n \in \mathbf{Z}}$  is an infinite perfect fit and is associated to a perfect fit horoball. The perfect fit horoball is invariant under  $\gamma$ . This finishes the proof of the lemma.  $\square$

Notice that if there are infinitely many leaves of  $\tilde{\Lambda}^s$  or  $\tilde{\Lambda}^u$  not separated from each other, then there are covering translations acting freely on  $\mathcal{O}$  and leaving invariant a scalloped region  $\mathcal{S}$ , see [Fe3]. If  $\gamma$  is of this type then  $\gamma$  will fix the 4 ideal points in  $\partial\mathcal{O}$  associated to the scalloped region  $\mathcal{S}$ . Hence the hypothesis in lemma 4.9 is needed and this is the only additional possibility that can occur in general: if the  $\gamma^n(L)$  does not escape compact sets for either  $n \rightarrow \infty$  or  $n \rightarrow -\infty$ , then the proof in the lemma shows that  $\gamma^n(L)$  converges to a bi-infinite collection of leaves non separated from each other. Let  $\mathcal{S}$  be the associated scalloped region. Here  $\gamma$  acts a translation in each collection of non separated leaves in  $\partial\mathcal{S}$ . It follows that  $\gamma$  has exactly 4 fixed points in  $\partial\mathcal{O}$ . Finally if  $\gamma$  has a fixed point in  $\mathcal{O}$ , then there are many more possibilities for the set of fixed points in  $\partial\mathcal{O}$ , in particular it can be infinite.

**Lemma 4.10.** *Suppose that  $\tilde{\Phi}$  does not have perfect fits and is not conjugate to suspension Anosov. For each  $\gamma \neq id$  in  $\pi_1(M)$ , there are distinct  $y, x$  in  $\mathcal{R}$  which are the only fixed points of  $\gamma$  in  $\mathcal{R}$  and  $x, y$  form a source/sink pair ( $y$  is repelling,  $x$  is attracting).*

*Proof.* As with almost all the proofs in this section, the proof will be a strong interplay between the pseudo-Anosov dynamics action on  $\partial\mathcal{O}$  and the induced action on  $\mathcal{R}$ . By remark 1) the only identifications of the map  $\varphi$  come from the ideal points of leaves of  $\mathcal{O}^s$  or  $\mathcal{O}^u$ .

Any  $\gamma$  in  $\pi_1(M)$  has at most one fixed point in  $\mathcal{O}$ : if  $\gamma$  fixes 2 points in  $\mathcal{O}$ , then it produces 2 closed orbits of  $\tilde{\Phi}$  which are freely homotopic to each other (or maybe freely homotopic to the inverse of each other or certain powers). By theorem 2.5, the lifts of the closed orbits are connected by a chain of lozenges and this produces perfect fits in the universal cover – disallowed by hypothesis.

Suppose first that  $\gamma$  is associated to a periodic orbit of  $\tilde{\Phi}$  – singular or not. Also  $\gamma$  need not correspond to an indivisible closed orbit. Let  $\beta$  be the orbit of  $\tilde{\Phi}$  with  $\gamma(\beta) = \beta$  and  $b = \Theta(\beta)$  be the single fixed point of  $\gamma$  in  $\mathcal{O}$ . Suppose without loss of generality that  $\gamma$  is associated to an orbit of  $\tilde{\Phi}$  being traversed in the forward direction. We will show that the set of fixed points of  $\gamma$  (or a power of  $\gamma$ ) in  $\partial\mathcal{O}$  is the

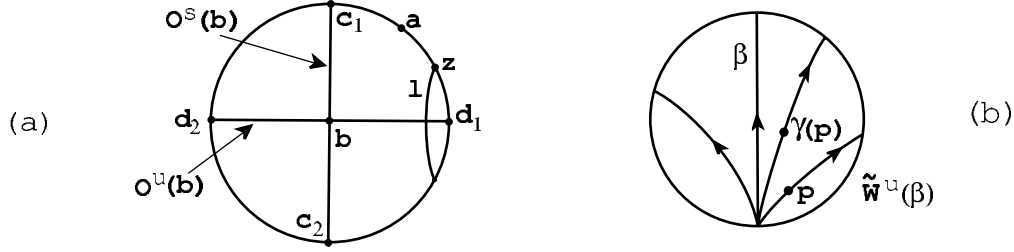

Figure 16: a. The action of  $\gamma$  in  $\mathcal{D}$  and  $\partial\mathcal{O}$ , b. Action of  $\gamma$  in  $\widetilde{W}^u(\beta)$ .

union  $\partial\mathcal{O}^s(b) \cup \partial\mathcal{O}^u(b)$  and also that  $\partial\mathcal{O}^s(b)$  is the set of attracting fixed points for  $\gamma$  and  $\mathcal{O}^u(b)$  is the set of repelling fixed points of  $\gamma$ .

Assume first that  $\gamma$  leaves invariant the prongs of  $\mathcal{O}^u(b)$  and  $\mathcal{O}^s(b)$  and that  $\gamma$  is nonsingular. Let  $c_1, c_2$  in  $\partial\mathcal{O}$  be the ideal points of  $\mathcal{O}^s(b)$  and  $d_1, d_2$  the ideal points of  $\mathcal{O}^u(b)$ , see fig. 16, a.

Notice that  $\varphi(c_1) = \varphi(c_2)$  and similarly  $\varphi(d_1) = \varphi(d_2)$ . Let  $x = \varphi(c_1), y = \varphi(d_1)$ .

Clearly  $\gamma$  fixes  $c_1, c_2, d_1, d_2$ . Let  $I$  be the interval of  $\partial\mathcal{O}$  with endpoints  $c_1, d_1$  and not containing  $d_2$ . Since there are no perfect fits, then option (1) of proposition 3.33 has to occur. As  $d_1$  is an ideal point of a unstable leaf, then  $d_1$  has a neighborhood system in  $\mathcal{D}$  formed by stable leaves, all of which have to intersect  $\mathcal{O}^u(b)$ . Let  $l$  be one such leaf with ideal point  $z$  in  $I$ .

The action of  $\gamma$  in the set of orbits of  $\widetilde{W}^u(\beta)$  is contracting, see fig. 16, b. This is because  $\gamma$  is associated with the forward flow direction. Therefore  $\gamma^n(l)$  converges to  $\mathcal{O}^s(b)$  as  $n$  converges to infinity. It follows that  $\gamma^n(z)$  converges to  $c_1$  and so  $\gamma^n(a)$  converges to  $c_1$ . This shows that  $\gamma$  has only 2 fixed points in  $I$  and  $d_1$  is repelling,  $c_1$  is attracting. The other intervals of  $\partial\mathcal{O}$  defined by  $\partial\mathcal{O}^s(b) \cup \partial\mathcal{O}^u(b)$  are treated in the same fashion.

We claim that  $y, x$  form the source/sink pair for the action of  $\gamma$  in  $\mathcal{R}$ . Here

$$\gamma(x) = \gamma(\varphi(c_1)) = \varphi(\gamma(c_1)) = \varphi(c_1) = x$$

and similarly  $\gamma$  fixes  $y$ . For any other  $w$  in  $\mathcal{R}$  there is  $z$  in  $\mathcal{O} - \{c_1, c_2, d_1, d_2\}$  with  $w = \varphi(z)$ . Without loss of generality assume that  $z$  is in  $I$ . Then  $\gamma^n(z)$  converges to  $c_1$  and

$$\gamma^n(w) = \gamma^n(\varphi(z)) = \varphi(\gamma^n(z)) \rightarrow \varphi(c_1) = x$$

Similarly  $\gamma^n(w) \rightarrow y$  when  $n \rightarrow -\infty$ . So if  $\gamma$  leaves invariant the components of  $\partial\mathcal{O} - \{c_1, c_2, d_1, d_2\}$  then  $y, x$  for a source/sink pair for the action of  $\gamma$  in  $\mathcal{R}$ .

In the general case take a power of  $\gamma$  so that in  $\partial\mathcal{O}$  it fixes all points in  $\partial\mathcal{O}^s(b), \partial\mathcal{O}^u(b)$  and preserves orientation in  $\partial\mathcal{O}$ . Then apply the above arguments. The arguments show that, as a set,  $\partial\mathcal{O}^s(b)$  is invariant and attracting for the action of  $\gamma$  in  $\partial\mathcal{O}$  and  $\partial\mathcal{O}^u(b)$  is invariant and repelling for the action. All the points in  $\partial\mathcal{O}^s(b)$  are mapped to  $x$  by  $\varphi$  and all points in  $\partial\mathcal{O}^u(b)$  are mapped to  $y$ . Hence  $y, x$  is the source/sink pair for the action of  $\gamma$  in  $\mathcal{R}$ . This finishes the analysis of the case when  $\gamma$  does not act freely in  $\mathcal{O}$ .

We now analyse the case that  $\gamma$  acts freely in  $\mathcal{O}$ . The previous lemma produces  $a, b$  which are a source/sink pair for the action of  $\gamma$  on  $\partial\mathcal{O}$ . Since there are no perfect fits, the previous lemma shows that  $a \neq b$ . In fact the arguments of the previous lemma show that none of  $a, b$  can be the ideal point of a ray of a leaf of  $\mathcal{O}^s$  or  $\mathcal{O}^u$ . Therefore  $\varphi(a), \varphi(b)$  are also distinct.

Given  $L$  in the axis of  $\gamma$  in  $\mathcal{H}^s$ , let  $l = \Theta(L)$ . The ideal points of  $\mathcal{O}^s(l)$  separate  $a$  from  $b$  in  $\partial\mathcal{O}$ . Then the source/sink property for the action of  $\gamma$  on  $\partial\mathcal{O}$  immediately translates into a source/sink property for the action of  $\gamma$  on  $\mathcal{R}$  with source  $\varphi(a)$  and sink  $\varphi(b)$ . This finishes the proof of lemma 4.10.  $\square$

We now prove the first part of theorem 4.8.

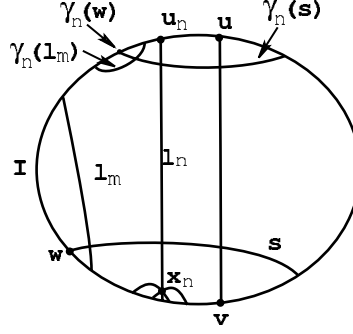

Figure 17: The case of line leaves converging to a limit.

**Theorem 4.11.** *Suppose that  $\Phi$  does not have perfect fits and is not conjugate to a suspension Anosov flow. Then  $\pi_1(M)$  acts on  $\mathcal{R}$  as a convergence group.*

*Proof.* Let  $\gamma_i$  be a sequence of distinct elements of  $\Gamma$ . Up to subsequence we can assume that either

- 1) each  $\gamma_i$  is associated to a singular closed orbit of  $\Phi$ ;
- 2) each  $\gamma_i$  is associated to a nonsingular closed orbit of  $\Phi$ ;
- 3) each  $\gamma_i$  is not associated to a closed orbit of  $\Phi$ .

Notice that 3) is equivalent to  $\gamma_i$  having no fixed points in the orbit space  $\mathcal{O}$ . There is some similarity between cases 1) and 2) which will be explored as we go along the proof.

Case 1 – Suppose the  $\gamma_i$  are all associated to singular orbits of the flow  $\Phi$ .

Let  $\alpha_i$  be orbits of  $\Phi$  with  $\gamma_i(\alpha_i) = \alpha_i$ . There are only finitely many singular orbits of  $\Phi$ , so we may assume up to subsequence that all  $\pi(\alpha_i)$  are the same. We may also assume that  $\gamma_i$  are associated to (say) the positive flow direction of  $\alpha_i$ , that is, if  $p_i$  in  $\alpha_i$  then  $\gamma_i(p_i) = \tilde{\Phi}_{t_i}(p_i)$  with  $t_i$  bigger than zero. Let  $x_i = \Theta(\alpha_i)$  and  $l_i = \mathcal{O}^s(x_i)$ .

Case 1.a – ( $l_i$ ) does not escape compact sets in  $\mathcal{O}$ .

It could be that, up to subsequence,  $l_i$  is constant. This means that there is  $\gamma$  in  $\pi_1(M)$  so that  $\gamma_i = \gamma^{n_i}$  and  $|n_i|$  converging to  $\infty$ . By the previous lemma there is a source/sink pair for the sequence ( $\gamma_i$ ).

Hence we may assume that up to subsequence all  $l_i$  are distinct and converge to a line leaf  $l$  of  $\mathcal{O}^s$ . Up to subsequence assume the  $l_i$  are nested and all in a fixed sector of  $l$ . Let  $u, v$  be the ideal points of  $l$ .

Claim 1 – There is an ideal point (say)  $v$  of  $l$  so that all ideal points of  $l_i$  except for one converge to  $v$ . The remaining ideal point of  $l_i$  converges to  $u$ .

Otherwise up to subsequence there are at least 2 ideal points  $u_i^1, u_i^2$  of  $l_i$  converging to  $u$  and likewise to  $v$ . Let  $x_i$  be the singular point of  $l_i$ . There is at least one unstable prong of  $\mathcal{O}^u(x_i)$  with an ideal point in  $\partial\mathcal{O}$  between  $u_i^1, u_i^2$  very near  $u$  and similarly an unstable prong of  $\mathcal{O}^u(x_i)$  with ideal point very near  $v$ . Their union is a slice  $s_i$  of  $\mathcal{O}^u(x_i)$  with one ideal point near  $u$  and one ideal point near  $v$ . This slice is not a line leaf of  $\mathcal{O}^u(x_i)$  since there are 2 prongs of  $\mathcal{O}^s(x_i)$  on both sides of this slice. The sequence  $(s_i)_{i \in \mathbb{N}}$  is nested and is bounded by  $l$ . Hence it converges to a leaf  $s$  of  $\mathcal{O}^u$ . By lemma 4.4 the ideal points of  $s_i$  converge to the ideal points of  $s$  and hence  $s$  has ideal points  $u, v$ . But  $u$  is also an ideal point of the line leaf  $l$  of  $\mathcal{O}^s$ . Since there are no perfect fits, no leaves of  $\mathcal{O}^s, \mathcal{O}^u$  share an ideal point. This proves claim 1.

Since at least 2 ideal points of  $\mathcal{O}^s(x_i)$  converge to  $v$  (as  $i \rightarrow \infty$ ) and ideal points of  $\mathcal{O}^s(x_i), \mathcal{O}^u(x_i)$  alternate in  $\partial\mathcal{O}$ , then at least one ideal point of  $\mathcal{O}^u(x_i)$  converges to  $v$  as  $i \rightarrow \infty$ . Suppose for a moment that not all endpoints of  $\mathcal{O}^u(x_i)$  converge to  $v$ . Then up to subsequence assume one of the endpoints converges to  $w$  distinct from  $v$ . By the escape lemma (lemma 4.4) up to subsequence  $(\mathcal{O}^u(x_i))$  converges to a leaf  $\delta$  of  $\mathcal{O}^u$  which has an ideal point  $v$ . But  $v$  is also an ideal point of line leaf  $l$  of  $\mathcal{O}^s$ , contradiction to no perfect fits by lemma 3.20. We conclude that all ideal points of  $\mathcal{O}^u(x_i)$  converge to  $v$ .

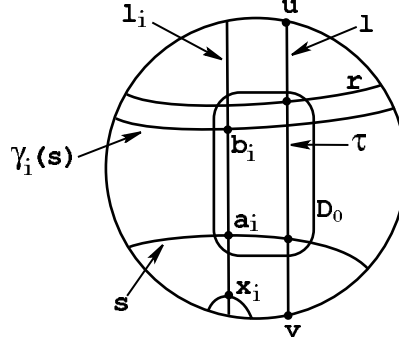

Figure 18: *The case when  $\gamma_i(s)$  converges to a leaf  $r$ .*

In order to finish the analysis of case 1.a it is enough to analyse the following situation, which we state as a separate case as it will be useful later on:

Case 1.b – Suppose that  $\mathcal{O}^u(x_i)$  escapes compact sets in  $\mathcal{O}$ , but  $\mathcal{O}^s(x_i)$  does not escape compact sets in  $\mathcal{O}$ .

Up to subsequence suppose that  $\mathcal{O}^s(x_i)$  converges to a line leaf  $l$  of  $\mathcal{O}^s$ . Since  $\mathcal{O}^u(x_i)$  escapes compact sets it converges to an ideal point of  $l$ , which we denote by  $v$  (again this follows from lemma 4.4). Let  $u$  be the other ideal point of  $l$ .

Let  $Z_i$  be the component of  $\partial\mathcal{O} - \partial\mathcal{O}^u(x_i)$  which contains  $u$ . In this case  $(Z_i)$  converges to the set  $\partial\mathcal{O} - \{v\}$ . Let  $u_i$  be the ideal point of  $\mathcal{O}^s(x_i)$  very close to  $u$ . Suppose first up to subsequence that  $\gamma_i(Z_i)$  is not equal to  $Z_i$  for all  $i$ . Then  $\gamma_i(Z_i)$  is an arbitrary small interval very close to  $v$ . This shows that  $\gamma_i|(\partial\mathcal{O} - v)$  converges locally uniformly to  $v$  and so in  $\mathcal{R}$  it follows that  $\gamma_i|(\mathcal{R} - \varphi(v))$  converges locally uniformly to  $\varphi(v)$ . So we assume from now on that  $\gamma_i(Z_i) = Z_i$  for all  $i$  and hence  $\gamma_i(u_i) = u_i$ . As the  $\gamma_i$  are associated to positive direction of the flow then the ideal points of  $l_i = \mathcal{O}^s(x_i)$  are attracting for the action of  $\gamma_i$  in  $\partial\mathcal{O}$  (lemma 4.10).

Claim 2 –  $\gamma_i|(\partial\mathcal{O} - v)$  converges locally uniformly to  $u$ .

We already know that  $\gamma_i(Z_i) = Z_i$  for all  $i$ . As  $v$  is an ideal point of a leaf of  $\mathcal{O}^s$  and  $\Phi$  has no perfect fits then  $v$  has a neighborhood basis defined by unstable leaves. So it suffices to show that for a fixed unstable leaf  $s$  intersecting  $l$ , the endpoints of  $\gamma_i(s)$  converge to  $u$ . Assume for simplicity that  $s$  is nonsingular.

Notice first that it may be that the sectors of  $l_i$  are not invariant under  $\gamma_i$ . A priori it may seem that this cannot happen because  $\gamma_i(Z_i) = Z_i$ . But in fact this occurs when  $\gamma_i$  acts in an orientation reversing way on  $\mathcal{O}$  or equivalently on  $\partial\mathcal{O}$ . Then the other components of  $\partial\mathcal{O} - \partial\mathcal{O}^u(x_i)$  are not  $\gamma_i$  invariant (there are  $\geq 2$  such other componets as  $x_i$  is singular), and the components of  $\partial\mathcal{O} - \mathcal{O}^s(x_i)$  are also not invariant.

To analyse claim 2, notice that  $\gamma_i(s)$  intersects  $l_i$ . If one endpoint of  $\gamma_i(s)$  converges to  $u$  (as  $i \rightarrow \infty$ ), then as seen above (using the escape lemma) the other endpoint of  $\gamma_i(s)$  also converges to  $u$  and so  $\gamma_i|(\partial\mathcal{O} - \{v\})$  converges locally uniformly to  $u$  as desired.

The remaining case is up to subsequence  $\gamma_i(s)$  converges to a leaf  $r$  of  $\mathcal{O}^u$ . Here  $u$  cannot be in  $\partial r$  and so  $r$  intersects  $l$ . Let  $\tau$  be the segment of  $l$  between  $s$  and  $r$  and  $D_0$  a neighborhood of it in  $\mathcal{O}$ . Let  $D$  be the image of a smooth section  $c_1 : D_0 \rightarrow \tilde{M}$  of  $\Theta$  restricted to  $D_0$ . Recall the orbits  $\alpha_i$  of  $\tilde{\Phi}$  with  $\gamma_i(\alpha_i) = \alpha_i$ . Let  $\beta_i = \pi(\alpha_i)$ , closed orbits of  $\Phi$ . Then  $\tilde{W}^s(\alpha_i) \cap D$  are segments of bounded length. Let

$$p_i = \tilde{W}^s(\alpha_i) \cap D \cap (s \times \mathbf{R}), \quad a_i = \Theta(p_i), \quad b_i = \Theta(\gamma_i(p_i)).$$

In  $D$  we have a segment  $r_i$  of bounded length from  $\tilde{\Phi}_{\mathbf{R}}(p_i)$  to a point in  $\gamma_i(\tilde{\Phi}_{\mathbf{R}}(p_i))$ . This is a segment in a stable leaf which contracts in positive flow direction. Flow forward  $p_i$  by time  $t_i$  until it is distance 1 from  $\alpha_i$  along  $\tilde{W}^s(\alpha_i)$ . Notice that  $p_i$  is far from  $\alpha_i$  for  $i$  big since  $x_i$  escapes compact sets in  $\mathcal{O}$  – hence



$t_i \gg 1$ . The segment  $r_i$  flows to a segment of arbitrary small length under  $\tilde{\Phi}_{t_i}$  since  $r_i$  has bounded length and  $t_i$  is very big. This is a contradiction: the endpoints of  $\tilde{\Phi}_{t_i}(r_i)$  both project in  $M$  to the same orbit in  $W^s(\beta_i)$  and the same local sheet of the foliation  $\Lambda^s$ , but not the same local flowline of  $\Phi$ . Hence these endpoints cannot be too close since the endpoint  $\pi(\tilde{\Phi}_{t_i}(p_i))$  is distance 1 from  $\beta_i$  in  $W^s(\beta_i)$ . We conclude that this cannot happen.

It follows that  $\gamma_i(s)$  cannot converge to a leaf intersecting  $l$  and so as seen before,  $\gamma_i(s)$  converges to  $u$  in  $\mathcal{D}$  and the endpoints of  $\gamma_i(s)$  also do. This proves claim 2.

This completes the analysis of case 1.b, and hence also of case 1.a that is, when the  $l_i = \mathcal{O}^s(x_i)$  do not escape compact sets in  $\mathcal{O}$ . The same proof applies when  $\mathcal{O}^u(x_i)$  do not escape compact sets.

Case 1.c – The sequences  $\mathcal{O}^s(x_i), \mathcal{O}^u(x_i)$  escape compact sets in  $\mathcal{O}$  and up to subsequence all ideal points of  $\mathcal{O}^s(x_i), \mathcal{O}^u(x_i)$  converge to the point  $v$  of  $\partial\mathcal{O}$ .

We can assume that  $v$  has a neighborhood basis defined by (say) stable leaves. Given a compact set  $C$  in  $\partial\mathcal{O} - v$  let  $s$  be a nonsingular stable leaf with ideal points very close to  $v$  and separating  $v$  from  $C$  in  $\mathcal{D}$ . For  $i$  big enough all the ideal points of  $\mathcal{O}^s(x_i), \mathcal{O}^u(x_i)$  are separated from  $C$  by  $\partial s$ . Then  $s$  is contained in a single interval of  $\partial\mathcal{O} - (\partial\mathcal{O}^s(x_i) \cup \partial\mathcal{O}^u(x_i))$  where  $\gamma_i$  does not have fixed points. If  $\gamma_i$  leaves this interval invariant then since  $\gamma_i(s)$  does not intersect  $s$  transversely, then  $\gamma_i(s)$  has both ideal points closer to  $v$  than those of  $s$  and so  $\gamma_i(C)$  is very close to  $v$  in  $\mathcal{D}$ . If  $\gamma_i$  does not leave that interval invariant then as seen above  $\gamma_i(C)$  is also very close to  $v$ . As  $s$  is arbitrary this shows  $\gamma_i(C) \rightarrow v$  uniformly. Therefore in  $\mathcal{R}$  it follows that  $\gamma_i|(\mathcal{R} - \varphi(v))$  converges locally uniformly to  $\varphi(v)$ .

This finishes the analysis of case 1: the  $\gamma_i$  are associated to singular orbits.

Case 2 –  $\gamma_i$  is associated to nonsingular periodic orbits.

This is very similar to case 1 and we can use a lot of the previous analysis. We also use the following fact, which is a uniform statement that orbits in leaves of  $\Lambda^u$  are backwards asymptotic:

Fact – Let  $\Phi$  be a pseudo-Anosov flow in  $M^3$ . For each  $a_0 > 0$  and  $\epsilon > 0$  there is time  $t_0 > 0$  so that if  $p, z$  are in the same leaf of  $\tilde{\Lambda}^u$  and there is a path  $\delta$  in  $\tilde{W}^u(p)$  from  $p$  to  $z$  with length bounded above by  $a_0$ , then there is a path from  $\tilde{\Phi}_t(p)$  to  $\tilde{\Phi}_{\mathbf{R}}(z)$  in  $\tilde{W}^u(p)$  of length less than  $\epsilon$  for all  $t \leq -t_0$ .

Equivalently the orbits  $\tilde{\Phi}_{\mathbf{R}}(p), \tilde{\Phi}_{\mathbf{R}}(z)$  are  $\epsilon$  close to each other backwards of  $\tilde{\Phi}_{-t_0}(p)$ . This is proved in pages 486-487 of [Fe6]. Notice it is not at all implied that  $\tilde{\Phi}_{-t_0}(p)$  and  $\tilde{\Phi}_{-t_0}(z)$  are  $\epsilon$ -close, which may not be true since  $p, z$  may be out of phase.

Case 2.a – Suppose that both  $\mathcal{O}^s(x_i)$  and  $\mathcal{O}^u(x_i)$  escape compact sets in  $\mathcal{O}$ .

This is very similar to the singular situation. A proof exactly as in case 1.c yields the result.

Case 2.b – Suppose that exactly one of  $\mathcal{O}^s(x_i)$  or  $\mathcal{O}^u(x_i)$  escapes compact sets.

Wlog assume that  $\mathcal{O}^u(x_i)$  escapes compact sets and  $\mathcal{O}^s(x_i)$  converges to a line leaf  $l$  of  $\mathcal{O}^s$ . Then a proof exactly as in Case 1.b yields the result.

Case 2.c – Assume up to subsequence that  $x_i$  converges to  $x$  in  $\mathcal{O}$ .

If  $x_i = x$  for infinitely many  $i$  then lemma 4.10 finishes the proof. So we may assume up to subsequence that  $x_i$  are all nonsingular, distinct from each other and all in the same sectors of  $\mathcal{O}^s(x)$  and  $\mathcal{O}^u(x)$ . This did not occur in the previous case because the set of singular points in  $\mathcal{O}$  is a discrete subset of  $\mathcal{O}$ . Let  $e$  be the boundary of this sector of  $\mathcal{O}^u(x)$  – a line leaf of  $\mathcal{O}^u(x)$ . Assume wlog that up to subsequence  $\gamma_i$  is associated to positive flow direction in  $\alpha_i$ . Hence  $\partial\mathcal{O}^s(x_i)$  is the attracting fixed point set for  $\gamma_i$  and  $\partial\mathcal{O}^u(x_i)$  is the repelling fixed point set for the action of  $\gamma_i$  on  $\partial\mathcal{O}$ .

We will show that  $\partial\mathcal{O}^u(x), \partial\mathcal{O}^s(x)$  forms a source/sink set for the sequence  $\gamma_i$  acting on  $\partial\mathcal{O}$ . Then  $a = \varphi(\partial\mathcal{O}^u(x)), b = \varphi(\partial\mathcal{O}^s(x))$  forms a source/sink pair for the sequence  $\gamma_i$  acting on  $\mathcal{R}$ . For simplicity assume that  $\gamma_i$  preserves the components of  $\mathcal{O}^s(x_i) - x_i, \mathcal{O}^u(x_i) - x_i$ . A similar proof works in the general case.

Let  $\alpha_i = \{x_i\} \times \mathbf{R}$  and  $\pi(\alpha_i)$  closed orbits of  $\Phi$ . Assume all  $\pi(\alpha_i)$  are distinct. Let  $v$  be a point in  $\partial e$  (which is a subset of  $\partial\mathcal{O}^u(x)$ ). For any small neighborhood  $A$  of  $v$  in  $\mathcal{D}$  let  $l$  nonsingular stable leaf intersecting  $\mathcal{O}^u(x)$  and contained in  $A$ . As  $\mathcal{O}^u(x_i)$  converges to  $e$  (a line leaf in)  $\mathcal{O}^u(x)$  then for  $i$  big enough  $\mathcal{O}^u(x_i)$  intersects  $l$  and has an ideal point  $v_i$  near  $v$ . Since  $v_i$  is a repelling fixed point for  $\gamma_i$  then  $\gamma_i(l)$  is closer to  $\mathcal{O}^s(x_i)$  than  $l$  is. Here  $\mathcal{O}^s(x_i)$  is close to  $\mathcal{O}^s(x)$  as well. Let  $L_i = \gamma_i(l) \times \mathbf{R}$ , a leaf of  $\tilde{\Lambda}^s$ .

The fact that is going to be used here is that the lengths of the periodic orbits  $\pi(\alpha_i)$  converge to infinity, which occurs because they are all distinct orbits. Draw a disk  $D$  transverse to  $\tilde{\Phi}$  containing segments  $r_i$  in  $\tilde{W}^u(\alpha_i)$  from  $p_i$  in  $\alpha_i$  to

$$z_i = (l \times \mathbf{R}) \cap \tilde{W}^u(\alpha_i) \cap D$$

and  $r_i$  transverse to  $\tilde{\Phi}$  in  $\tilde{W}^u(\alpha_i)$ . We can assume the  $r_i$  converges to  $r$ , which is a segment in  $\tilde{W}^u(p)$  (here  $p = \{x\} \times \mathbf{R}$ ) and so the  $r_i$  have diameter uniformly bounded above. Consider  $\gamma_i(r_i)$  which are segments of diameter bounded above, connecting  $\gamma_i(p_i)$  to  $\gamma_i(z_i)$ . Notice that  $\gamma_i(z_i)$  is in  $L_i$ . Choose

$$t_i \in \mathbf{R} \text{ with } \gamma_i(p_i) = \tilde{\Phi}_{t_i}(p_i). \text{ Then } t_i \rightarrow \infty \text{ and } p_i = \tilde{\Phi}_{-t_i}(\gamma_i(p_i))$$

By the fact above there are segments from  $p_i$  to  $\tilde{\Phi}_{\mathbf{R}}(\gamma_i(z_i))$  in  $\tilde{W}^u(\alpha_i)$  with diameter converging to 0 as  $i \rightarrow \infty$ . As the  $p_i$  are converging to the point  $p$  in  $\{x\} \times \mathbf{R}$ , this shows that  $\gamma_i(l)$  is converging to (a line leaf of)  $\mathcal{O}^s(x)$ .

This shows that  $\partial\mathcal{O}^u(x)$  is the repelling fixed point set for  $\gamma_i$  and  $\partial\mathcal{O}^s(x)$  is the attracting set. This finishes the analysis of case 2.

Case 3 – All the  $\gamma_i$  act freely on  $\mathcal{O}$ .

This case is extremely long.

By lemmas 4.9 and 4.10 each  $\gamma_i$  acts on  $\partial\mathcal{O}$  with only two distinct fixed points  $v_i, u_i$  forming a source/sink pair, that is, hyperbolic dynamics in  $\partial\mathcal{O}$ . Assume up to subsequence that  $u_i$  converges to  $u$  and  $v_i$  converges to  $v$  in  $\partial\mathcal{O}$ . It may be that  $u$  is equal to  $v$ . Ideally we would like to show that  $\gamma_i|(\partial\mathcal{O} - v)$  converges locally uniformly to  $u$ . Very surprisingly this is not true in general, see the counterexample after the end of the proof.

We first consider the situation that  $u = v$ . This is dealt with exactly as in case 1.c.

Hence from now on suppose that  $u \neq v$ . Assume wlog that  $v$  is not an ideal point of a leaf of  $\mathcal{O}^s$  and hence by lemma 3.33,  $v$  has a neighborhood system defined by stable leaves. Let  $l$  be a non singular stable leaf with ideal points near  $v$ , separating it from  $u$ . This uses the fact that  $u \neq v$ . If some subsequence of  $(\gamma_i(l))$  escapes compact sets in  $\mathcal{O}$ , then by the escape lemma (lemma 4.4 part (iii)), the ideal points of  $\gamma_i(l)$  have to be very near each other. Then these ideal points have to be very near  $u_i$  and hence very near  $u$ . If this happens for  $l$  arbitrarily near  $u$ , then this implies the convergence property: compact sets of  $\partial\mathcal{O} - \{v\}$  converge to  $u$  under  $\gamma_i$ . Hence by way of contradiction assume for the remainder of case 3:

Running hypothesis for the remainder of case 3 – Up to subsequence suppose that there is  $l^c$  with ideal points very near  $v$  and separating it from  $u$ , so that  $\gamma_i(l^c)$  converges to a line leaf  $l^d$  of some leaf of  $\mathcal{O}^s$ .

There are 2 possibilities.

Case 3.1 – The point  $v$  is not an ideal point of a leaf of  $\mathcal{O}^u$ .

Then there is a neighborhood system of  $v$  defined by unstable leaves as well. For a stable leaf  $l$  as above let  $\partial l = \{a_1, a_2\}$ , where we suppress the dependence on  $l$  for notational simplicity.. Consider the collection of unstable leaves  $\{s \in \mathcal{O}^u \mid s \cap l \neq \emptyset\}$ .

We claim that if  $l$  is close to  $v$  then so are all the possible  $s$ . Otherwise vary  $l$  and take limits of  $l$  approaching  $v$  and also take limits of such  $s$  with one ideal point not close to  $v$ , then using the escape lemma one produces an unstable leaf with ideal point  $v$ , contrary to assumption.

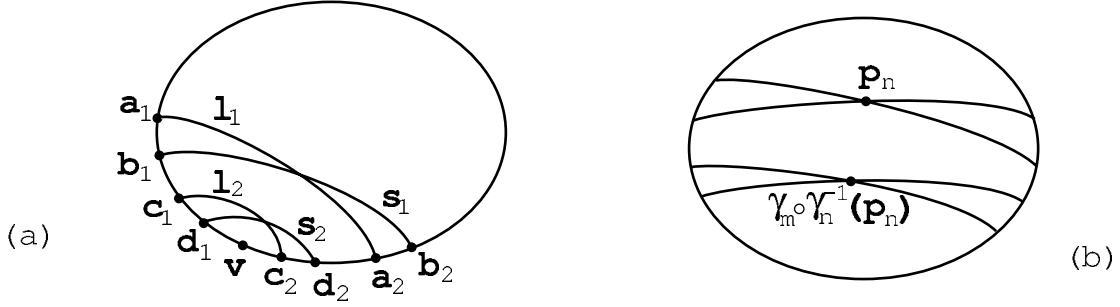
 Figure 19: *a. Set up in  $\mathcal{O}$ , b. Producing fixed points.*

In the same way if  $s \cap l$  is near  $a_1$  in  $\mathcal{D}$  then  $s$  is near  $a_1$  in  $\mathcal{D}$  and has all ideal points near  $a_1$ . Otherwise consider a sequence  $s_n \in \mathcal{O}^u$  with  $s_n \cap l$  converging to  $a_1$ . If  $s_n$  does not escape in  $\mathcal{O}$ , then the escape lemma produces an unstable leaf with ideal point  $a_1$ , contrary to hypothesis in this case. Since  $s_n$  escapes compact sets and has  $s_n \cap l$  converging to  $a_1$ , lemma 4.4 again implies that the ideal points of  $s_n$  also converge to  $a_1$ . Similarly if  $s \cap l$  is near  $a_2$  in  $\mathcal{D}$  then  $s$  is near  $a_2$  in  $\mathcal{D}$ . It follows that there is a unique unstable leaf  $s'$  intersecting  $l$  so that  $s'$  has a singularity in  $W$  and has at least 2 prongs contained in  $W$  and enclosing  $v$ . Enclosing  $v$  means that if  $b'_1, b'_2$  are the ideal points of these 2 prongs then  $a_1, b'_1, v, b'_2, a_2$  are all distinct and circularly ordered in  $\partial\mathcal{O}$  (under some circular order in  $\partial\mathcal{O}$ ). There is then one prong of  $s'$  exiting  $W$  so that together with a prong inside  $W$  it defines a small neighborhood of  $v$ . The union of these two prongs is a slice  $s_1$  in  $s'$ . Let  $\partial s_1 = \{b_1, b_2\}$  with  $b_1$  an ideal point of  $W$ . Let  $l_1 = l$ . This was the first step of the process, which is going to be done twice. We know that  $\gamma_i(l_1)$  does not limit to  $u$  and we can assume up to subsequence that  $\gamma_i(l_1)$  converges to  $l_0$  a stable leaf with no limit point in  $u$ .

Now redo the process above to obtain a leaf  $l_2$  of  $\mathcal{O}^s$  and a slice  $s_2$  of  $\mathcal{O}^u$  which are closer to  $v$ . Let  $\partial l_2 = \{c_1, c_2\}$  and  $\partial s_2 = \{d_1, d_2\}$ . By doing this procedure 3 or 4 times, we can arrange the construction so that for instance  $a_1, b_1, c_1, d_1, v, c_2, d_2, a_2, b_2$  are all distinct and circularly ordered in  $\partial\mathcal{O}$ , see fig. 19, a.

The  $\gamma_i(l_2), \gamma_i(s_2)$  do not escape to  $u$ , because they are bounded by  $l_d$ . Let  $j = 1, 2$ . We may assume that the sequence  $(\gamma_i(l_j))$  is nested and converges to  $l'_j$  and likewise  $(\gamma_i(s_j))$  is nested and converges to  $s'_j$ , as  $i \rightarrow \infty$  for  $j = 1, 2$ . Because of the set up of the ideal points as above then  $l'_1$  has no common ideal point with  $l'_2$ . If for instance  $\lim \gamma_i(a_1) = \lim \gamma_i(c_1)$  then it is also equal to  $\lim \gamma_i(b_1)$  and one produces one unstable leaf  $s'_1$  sharing an ideal point with a stable leaf  $l'_1$  – disallowed by no perfect fits. It follows that all four limits of ideal points are distinct. Fix  $n$  very big and let  $m \gg n$ . Since  $\gamma_m(l_1), \gamma_n(l_1)$  are both very near  $l'_1$  and  $\gamma_m(s_1), \gamma_n(s_1)$  are very near  $s'_1$  then

$$\gamma_m(l_1 \cap s_1) \text{ is very near } \gamma_n(l_1 \cap s_1) = p_n$$

Or  $\gamma_m \circ \gamma_n^{-1}(p_n)$  is very near  $p_n$ , see fig. 19, b. If  $l'_1 \cap s'_1$  is singular assume up to subsequence that all  $\gamma_i(l_1 \cap s_1)$  are in the intersection of closures of sectors of  $\mathcal{O}^s(l'_1 \cap s'_1)$  and  $\mathcal{O}^u(l'_1 \cap s'_1)$ . With these conditions and the fact that  $\gamma_m, \gamma_n$  are distinct, then the shadow lemma for pseudo-Anosov flows [Han, Man] implies that  $\gamma_m \circ \gamma_n^{-1}$  has a fixed point very near  $p_n$ . Similarly there is a fixed point of  $\gamma_m \circ \gamma_n^{-1}$  near  $\gamma_n(l_2 \cap s_2)$ . Since  $l'_1 \cap s'_1, l'_2 \cap s'_2$  are different, then for  $n, m$  sufficiently big these two fixed points are different. But then  $\gamma_m \circ \gamma_n^{-1}$  would have two distinct fixed points in  $\mathcal{O}$  – which is disallowed by the no perfect fits condition. This cannot happen. Therefore  $\gamma_i(l)$  converges to  $u$  for any  $l$  close enough to  $v$  and this finishes the analysis of case 3.1.

**Case 3.2** – Suppose that  $v$  is an ideal point of a leaf  $s$  of  $\mathcal{O}^u$ .

The proof of this subcase is very long. In this case we do not necessarily obtain that  $\gamma_i|(\partial\mathcal{O} - v)$  converges locally uniformly to  $u$ . Suppose  $l$  is nonsingular, intersects  $s$  and  $W \cap s$  has no singular points. As in case 3.1 we only have to deal with the case that  $\gamma_i(l)$  does not escape compact sets in  $\mathcal{O}$ .

From now on in this case fix this leaf  $l$  of  $\mathcal{O}^s$ .

Assume that  $\gamma_i(l)$  converges to a line leaf  $l^*$  of a leaf  $l_0$  of  $\mathcal{O}^s$ . Let  $l'$  be any stable leaf intersecting  $s$  and closer to  $v$  than  $l$  is.

The first situation is that up to subsequence  $\gamma_i(l')$  converges to  $l'_0$  different from  $l_0$ . Then  $l_0, l'_0$  do not share an ideal point – because of the no perfect fits hypothesis. Since  $\gamma_i(s)$  intersects  $\gamma_i(l), \gamma_i(l')$  and  $\gamma_i(l), \gamma_i(l')$  converge to  $l_0, l'_0$  not sharing an ideal point then  $\gamma_i(s)$  cannot escape in  $\mathcal{O}$ . This follows directly from the escape lemma.

Hence assume  $\gamma_i(s)$  converges to a leaf  $s_1$  of  $\mathcal{O}^u$ . Notice that  $s_1$  intersects  $l_0$  and  $l'_0$  for otherwise, by the escape lemma again,  $s_1$  will share ideal point with at least one of  $l_0, l'_0$ , again disallowed by the no perfect fits condition. Therefore  $\gamma_i(l \cap s)$  converges to  $l_0 \cap s_1$  and  $\gamma_i(l' \cap s)$  converges to  $l'_0 \cap s_1$ . As seen before, if  $n, m$  are big enough this produces 2 distinct fixed points of  $\gamma_m \circ \gamma_n^{-1}$  – one near  $l_0 \cap s_1$  and one near  $l'_0 \cap s_1$ . This is disallowed.

We conclude that for any  $l'$  stable leaf intersecting  $s$  and separating  $v$  from  $l$ , the sequence  $\gamma_i(l')$  also converges to  $l^*$ . Let

$$w, w' \quad \text{be the ideal points of } l^*.$$

Let  $z, z'$  be the ideal points of  $l$ . Let  $I, I'$  be the disjoint half open intervals of  $\partial\mathcal{O}$  with one ideal point in  $z, z'$  and the other in  $v$ , that is,  $z \in I$  but  $v$  is not in  $I$  (for some orientation of  $\mathcal{O}$  then  $I = [z, v), I' = (v, z']$ ). Assume wlog that  $\gamma_i(z)$  converges to  $w$ . The arguments above show that  $\gamma_i(I)$  converges locally uniformly to  $w$  and  $\gamma_i(I')$  converges locally uniformly to  $w'$ .

The strategy to prove case 3.2 is as follows: Using the no perfect fits condition we will incrementally upgrade the property above to show that  $\gamma_i|(\partial\mathcal{O} - \partial s)$  converges locally uniformly to  $\partial l^*$  – this last one is a set, not a single point. This means that for any  $C$  compact contained in  $\partial\mathcal{O} - \partial s$ , then for  $i$  big enough  $\gamma_i(C)$  is contained in a small neighborhood of  $\partial l^*$ . Notice that  $s$  may be singular so the set  $\partial\mathcal{O} - \partial s$  may have more than 2 components.

Recall that in case 3.2 the leaf  $l$  of  $\mathcal{O}^s$  is fixed. Consider an arbitrary unstable leaf  $s'$  intersecting  $l$ , with  $s' \neq s$ . Then  $s'$  has at least one ideal point in either  $I$  or  $I'$ . If  $s'$  has an ideal point  $t$  in  $I$  then  $\gamma_i(t)$  converges to  $w$ . Since no unstable leaf has ideal point  $w$  it follows from the escape lemma that  $\gamma_i(s')$  converges to  $w$  in  $\mathcal{D}$ . Let now  $J$  ( $J'$ ) be the component of  $(\partial\mathcal{O} - \partial s)$  containing  $z$  ( $z'$ ) (hence  $I \subset J, I' \subset J'$ ). The above arguments imply that  $\gamma_i(J)$  converges locally uniformly to  $w$  and  $\gamma_i(J')$  converges locally uniformly to  $w'$ . To prove this use the fact that for any  $v \in J - \bar{I}$  there is  $s'$  unstable leaf with  $s' \cap l \neq \emptyset$  and  $\partial s'$  separating  $\partial s$  from  $v$  in  $\partial\mathcal{O}$ . This last statement follows from the escape lemma and the fact that there are no leaves in  $\mathcal{O}^u$  non separated from  $s$ .

If  $s$  is nonsingular we are done. This is because if  $v, t$  are the ideal points of  $s$ , then  $\varphi(v) = \varphi(t) = y$  and  $\varphi^{-1}(y) = \{v, t\}$ . For any compact set  $C$  in  $\mathcal{R} - y$  there is a compact set  $V$  in  $\partial\mathcal{O} - \{v, t\}$  with  $C \subset \varphi(V)$ , since  $\varphi^{-1}(y) = \{v, t\}$ . Hence  $V$  is contained in the union of 2 compact intervals  $V_1, V_2$  in  $\partial\mathcal{O} - \{v, t\}$  so up to reordering  $V_1 \subset J$  and  $V_2 \subset J'$ . Hence

$$\gamma_i|V_1 \text{ converges to } w \quad \text{and} \quad \gamma_i|V_2 \text{ converges to } w'.$$

Notice  $\varphi(w) = \varphi(w')$  and let this be  $x$ . This shows that in  $\mathcal{R}$ ,  $\gamma_i|C$  converges uniformly to  $x$ . Hence  $y, x$  is the source/sink pair for  $\gamma_i$ . With more analysis one can show that  $u$  is not an ideal point of  $s$  and  $u$  is an ideal point of  $l_0$ . We do not provide the arguments as we will not use that.

To finish the analysis of case 3.2, we suppose from now on that  $s$  is singular with  $n$  prongs. Let  $r_1 = v$ , let  $r_2$  be the other endpoint of  $J$  – this is also an ideal point of  $s$  and let  $r_n$  be the similar endpoint of  $J'$ . Complete the ideal points of  $s$  circularly to  $r_1, \dots, r_n$ . Let  $p$  be the singular point in  $s$ , see fig. 20, a. Let  $e$  be the stable leaf through  $p$ . Then  $e$  has a prong with ideal point  $a_1$  in  $J$  and one with ideal point  $a_n$  in  $J'$ . Order the other endpoints of  $e$  as  $a_1, \dots, a_n$ . Let  $e^*$  be the line leaf of  $e$  with ideal points  $a_1, a_n$ .

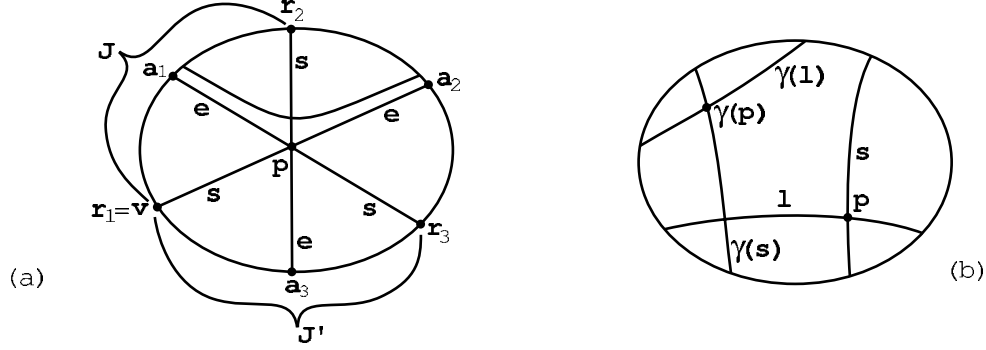

Figure 20: *a. Trapping the orbits in the singular case ( $n = 3$ ), b. An interesting counterexample.*

We proved above that  $\gamma_i(a_1)$  converges to  $w$  and  $\gamma_i(a_n)$  converges to  $w'$ . There are two options: 1)  $\gamma_i(p)$  does not escape compact sets in  $\mathcal{O}$ ; 2)  $\gamma_i(p)$  escapes compact sets in  $\mathcal{O}$ .

Option 1 – Suppose that  $\gamma_i(p)$  does not escape compact sets in  $\mathcal{O}$ .

Up to subsequence  $\gamma_i(p)$  converges in  $\mathcal{O}$  so assume that  $\gamma_i(p) = p_0$  for  $i \geq i_0$  (using the fact that  $p$  is singular). Let  $f$  be the generator of the isotropy group of  $p_0$  fixing also  $\gamma_{i_0}(a_1) = w$ ,  $\gamma_{i_0}(a_n) = w'$  and  $f$  associated to the forward direction in the orbit  $\{p_0\} \times \mathbf{R}$ . Since  $\gamma_i(a_1), \gamma_i(a_n)$  converge to  $w, w'$ , there is  $i_0$  so that for  $i > i_0$ :

$$\gamma_i = f^{m_i} \circ \gamma_{i_0}, \quad m_i \in \mathbf{Z}$$

Here  $w$  is an attracting point, so  $m_i$  converges to  $+\infty$ . Lemma 4.10 now implies that for any compact set  $C$  in  $\partial\mathcal{O} - \partial s$  then  $\gamma_i(C)$  is in a small neighborhood of  $\partial\mathcal{O}^s(p_0)$ . All points of  $\partial s$  are identified under  $\varphi$  and similarly for  $\partial\mathcal{O}^s(p_0)$ . Let  $y = \varphi(\partial s)$ ,  $x = \varphi(\partial\mathcal{O}^s(p_0))$ . Then in  $\mathcal{R}$ ,  $\gamma_i(\mathcal{R} - y)$  converges locally uniformly to  $x$ . This finishes the argument for option 1).

Option 2 – Suppose that  $\gamma_i(p)$  escapes compact sets in  $\mathcal{O}$ .

Since  $\gamma_i(e^*)$  converges to  $l^*$  and  $\gamma_i(p)$  is in  $\gamma_i(e^*)$ , the escape lemma implies that  $\gamma_i(p)$  converges to either  $w$  or  $w'$ . Suppose without loss of generality that  $\gamma_i(p)$  converges to  $w$ . Then  $\gamma_i(a_n)$  converges to  $w'$  and all the ideal points  $a_1, \dots, a_{n-1}$  converge to  $w$  under  $\gamma_i$ . Here is the justification of this statement: If for some  $j$  in  $2, \dots, n-1$ ,  $\gamma_i(a_j) \rightarrow w'$ , then also  $\gamma_i(a_{n-1}) \rightarrow w'$ . Hence  $\gamma_i(r_n) \rightarrow w'$ . But since  $\gamma_i(p) \rightarrow w$ , then that unstable prong of  $\mathcal{O}^u(p)$  converges to an unstable leaf with one ideal point in  $w$  and another in  $w'$ . This is disallowed under no perfect fits (in fact this cannot happen in general, but we will not need that). Therefore  $\gamma_i(a_n) \rightarrow w'$  and  $\gamma_i(a_j) \rightarrow w$  for  $j = 1, \dots, n-1$ .

Let  $J_2$  be the interval of  $\partial\mathcal{O}$  bounded by  $v (= r_1)$  and  $r_n$  and so that  $J_2$  is disjoint from  $J'$  – that is,  $J_2 = \partial\mathcal{O} - \overline{J'}$ . If  $A$  is the region of  $J_2$  between  $a_{n-1}$  and  $r_n$  we claim that  $\gamma_i(J_2 - A)$  converges to  $w$ . Here  $(\gamma_i(a_j))$  converges to  $w$ ,  $1 \leq j \leq n-1$ . The nonsingular unstable leaves  $s'$  intersecting  $\mathcal{O}^s(p)$  in the prong with ideal point  $a_{n-1}$  have one ideal point in  $A$  and another ideal point  $y$  in  $J_2 - A$ . Since  $\gamma_i(a_{n-1}) \rightarrow w$ , then  $\gamma_i(y) \rightarrow w$ . This implies that the ideal points of  $s'$  both have to converge to  $w$  under  $\gamma_i$ . Since  $\gamma_i$  is a homeomorphism of  $\partial\mathcal{O}$  it now follows that  $\gamma_n(J_2)$  converges locally uniformly to  $w$ . As  $\gamma_i(J')$  converges locally uniformly to  $w'$  then

$$\gamma_i | (\partial\mathcal{O} - \partial s) \text{ converges locally uniformly to } \{w, w'\}.$$

Notice that  $\partial\mathcal{O}$  is the disjoint union of  $J_2, J', r_1, r_n$ . If  $y = \varphi(\partial s)$  and  $x = \varphi(w)$  then  $y, x$  is the source/sink pair for a subsequence  $\gamma_i$  acting on  $\mathcal{R}$ . This finishes case 3.2.

This shows that  $\pi_1(M)$  acts as a convergence group on  $\mathcal{R}$  and finishes the proof of theorem 4.11.  $\square$

**Remark** – We construct an example as in case 3.2 where the sequence  $(\gamma_i)_{i \in \mathbf{N}}$  does not have source/sink pair the points  $v, u$  for the action on  $\partial\mathcal{O}$  as naively expected in case 3.2. In fact the source is a collection

of points and so is the sink. We start with  $\Phi$  a pseudo-Anosov flow without perfect fits and not conjugate to suspension Anosov. For simplicity assume that everything is orientable. In addition assume that  $\Phi$  is transitive. The tricky thing is to get  $\gamma_i$  to act freely on  $\mathcal{O}$ . Let  $s = \mathcal{O}^u(p), l = \mathcal{O}^s(p)$  where  $p$  is periodic, nonsingular. Let  $\gamma$  in  $\pi_1(M)$  with  $\gamma(s)$  intersecting  $l$  and so that  $\gamma(l)$  does not intersect  $s$ , see fig. 20, b. Since  $\Phi$  is transitive it is always possible to find such  $\gamma$  unless there is a product region in that quarter of  $p$  – but then  $\Phi$  would be conjugate to a suspension Anosov flow, contrary to assumption. Let  $f$  be the generator of the isotropy group of  $\gamma(p)$  leaving invariant all points in  $\partial\mathcal{O}^s(\gamma(p)), \partial\mathcal{O}^u(\gamma(p))$  and associated to the positive direction of the flow line. Let  $\gamma_i = f^i \circ \gamma$ . Then  $\{\gamma_i\}_{i \in \mathbf{N}}$  are all distinct.

Suppose that for some  $j$ , the  $\gamma_j$  has a fixed point. Fix  $j$  and let  $h = \gamma_j$ . Notice that  $l, h(l)$  ( $= \gamma(l)$ ) both intersect a common unstable leaf  $\gamma(s)$ ; also  $s, h(s)$  ( $= \gamma(s)$ ) intersect the stable leaf  $l$  and  $s, h(l)$  do not intersect. If  $h^m(l)$  converges to  $r$  as  $m \rightarrow \infty$  then  $h(r) = r$ . This is because the leaf space  $\mathcal{H}^s$  of  $\tilde{\Lambda}^s$  is Hausdorff. Hence  $h$  has a fixed point  $q$  in  $r$ . Then  $h(\mathcal{O}^u(q)) = \mathcal{O}^u(q)$  and  $\mathcal{O}^u(q)$  intersects  $h^m(l)$  for  $m$  big enough and hence for all  $m$ . But since  $h$  contracts  $h^m(l)$  towards  $\mathcal{O}^s(q)$  then it expands unstable leaves away. In particular  $s$  cannot intersect  $r$ . However by construction  $h$  moves  $s$  and  $l$  in the same direction and hence  $\gamma_j(s)$  is closer to  $\mathcal{O}^u(q)$  than  $s$  is. It follows that  $h^m(s)$  converges to a leaf  $t$  and  $t$  does not intersect  $r$ . Hence  $h(r) = r, h(t) = t$  and  $r \cap t = \emptyset$ . This produces two fixed points of  $h$  in  $\mathcal{O}$ . Hence theorem 2.5 implies that there are perfect fits, contrary to assumption. This contradiction shows that  $h$  does not have any fixed point in the component of  $\mathcal{O} - l$  containing  $h(l)$ . Now consider  $h^{-1}$ :  $h^{-1}(l) = \gamma^{-1}(l)$  does not intersect  $l$  and  $h^{-1}(s) = \gamma^{-1}(s)$  intersects  $l$ . So the same argument as above shows that  $h$  does not have a fixed point in the component of  $\mathcal{O} - l$  containing  $h^{-1}(l)$ . Hence  $h$  does not have fixed points in  $\mathcal{O}$  and acts freely.

It follows that each  $\gamma_i$  acts freely on  $\mathcal{O}$  and has 2 fixed points  $v_i, u_i$  in  $\partial\mathcal{O}$ . In addition as  $i \rightarrow \infty$ ,  $u_i$  converges to an ideal point of  $\gamma(l)$  and  $v_i$  converges to an ideal point of  $s$  – the one separated from  $\gamma(l)$  by  $l$ . So this is exactly the situation in case 3.2 of theorem 4.11. Notice also that  $\gamma_i(s) = \gamma(s)$  and  $\gamma_i(l) = \gamma(l)$  so the collection  $\{\gamma_i\}_{i \in \mathbf{N}}$  does not act properly discontinuously in  $\mathcal{O}$ . Here  $\gamma_i(\partial s) = \gamma(\partial s)$  and  $\gamma_i(\partial l) = \partial\gamma(l)$ , so there are not two points in  $\partial\mathcal{O}$  forming a source/sink pair for the action of  $(\gamma_i)$  on  $\partial\mathcal{O}$ . Still  $\gamma_i|(\partial\mathcal{O} - \partial s)$  converges locally uniformly to  $\partial\gamma(l)$ .

The next goal is to show that every point in  $\mathcal{R}$  is a conical limit point.

**Theorem 4.12.** *Let  $\Phi$  a pseudo-Anosov flow without perfect fits and not conjugate to a suspension Anosov flow. Let  $\mathcal{R}$  be the associated sphere quotient of  $\partial\mathcal{O}$ . Then every point in  $\mathcal{R}$  is a conical limit point for the action of  $\pi_1(M)$  on  $\mathcal{R}$ . Hence  $\pi_1(M)$  acts as a uniform convergence group on  $\mathcal{R}$ .*

*Proof.* The last statement follows from the first because theorem 4.7 implies that the action of  $\pi_1(M)$  on the space of distinct triples of  $\mathcal{R}$  is cocompact.

We show that any  $x$  in  $\mathcal{R}$  is a conical limit point for the action of  $\pi_1(M)$ . There are 3 cases:

Case 1 –  $x = \varphi(z)$  where  $z$  is the ideal point of  $l$  of  $\mathcal{O}^s$  or  $\mathcal{O}^u$  and there is  $\gamma \neq \text{id}$  in  $\pi_1(M)$  with  $\gamma(l) = l$ .

Since all ideal points of  $l$  are taken to  $x$  under  $\varphi$  and  $\gamma$  permutes the ideal points of  $l$ , it follows that  $\gamma(x) = x$ . Assume that  $x$  is the repelling fixed point of  $\gamma$  – up to taking an inverse if necessary. Let  $\gamma_i = \gamma^i, i \geq 0$ . Then  $\gamma_i(x) = x$  so  $\gamma_i(x)$  converges to  $x$ . Let  $c$  be the other fixed point of  $\gamma$  in  $\mathcal{R}$ . For any  $y$  distinct from  $x$  in  $\mathcal{R}$  it follows from lemma 4.10, that  $\gamma_i(y) = (\gamma^i)(y)$  converges to  $c$ . Hence  $x$  is a conical limit point.

Case 2 –  $x = \varphi(z)$  where  $z$  is an ideal point of  $l$  of  $\mathcal{O}^s$  or  $\mathcal{O}^u$  and  $l$  is not invariant under any  $\gamma$  of  $\pi_1(M)$ .

Suppose without loss of generality that  $l$  is an unstable leaf. Let  $L = l \times \mathbf{R}$  a leaf of  $\tilde{\Lambda}^u$ . Here  $\pi(L)$  does not have a periodic orbit of  $\Phi$ . Let  $\alpha$  be an orbit of  $\tilde{\Phi}$  in  $L$ . We look at the asymptotic behavior of  $\pi(\alpha)$  in the negative direction (all orbits in  $L$  are backward asymptotic, so this argument is independent of the orbit  $\alpha$  in  $L$ ). If  $\pi(\alpha)$  limits only in a singular orbit then  $\pi(\alpha)$  must be in the unstable leaf of a singular orbit, contrary to assumption.

For each  $i$  choose  $p_i$  in  $\alpha$  with  $(p_i)$  escaping in the negative direction and  $(\pi(p_i))$  converging to a nonsingular point  $\mu$  in  $M$ . By discarding a number of initial terms, we can assume that all  $\pi(p_i)$  are in

a neighborhood  $V$  of  $\mu$  to which the shadow lemma can be applied. There are  $\gamma_i$  in  $\pi_1(M)$  with  $\gamma_i(p_i)$  in  $V$ . By the shadow lemma the  $\gamma_i$  correspond to closed orbits  $\beta_i$  of the flow  $\Phi$ . In particular we assume that  $V$  is sufficiently small, so that there is still a small neighborhood  $U$  of  $\mu$  with  $\overline{V} \subset U$  and there are lifts  $\tilde{\beta}_i$  of  $\beta_i$  with points in  $U$ . We assume that  $\overline{U}$  does not intersect any singular orbit. It follows that no  $\beta_i$  is a singular orbit. Since  $\tilde{\beta}_i, \gamma_i(\alpha)$  have points near  $p_1$ , we may also assume up to subsequence that both sequences converge. Let  $\tau$  be the limit of  $(\tilde{\beta}_i)$ . Hence  $\tau$  is also not a singular orbit. Notice that a priori there is no relation between  $\mu$  and  $\tau$  except that  $\mu$  is near  $\tau$ . Let also  $\delta$  be the limit of  $(\gamma_i(\alpha))$ . Notice that  $\pi(\delta)$  has a point in  $\overline{V}$ .

Each  $\gamma_i$  takes  $p_i$  to a point very close to  $p_1$  and the  $p_i$  escape in  $\widetilde{M}$  with  $i$ , so up to subsequence we can assume that the  $\gamma_i$  are all distinct. Hence the length of  $\beta_i$  goes to infinity (the  $\beta_i$  does not have to be an indivisible closed orbit). Let  $q_i = \Theta(\tilde{\beta}_i)$ , so  $(q_i)$  converges to  $q_0 = \Theta(\tau)$ . Let

$$\partial\mathcal{O}^u(q_0) = \{s, s'\}, \quad \partial\mathcal{O}^s(q_0) = \{t, t'\}, \quad \partial\mathcal{O}^u(q_i) = \{s_i, s'_i\}, \quad \partial\mathcal{O}^s(q_i) = \{t_i, t'_i\}$$

Since the points  $p_i$  are flow backwards of  $p_1$  in  $\alpha$  and  $p_i$  is sent near  $p_1$  by  $\gamma_i$ , then  $\gamma_i$  corresponds to the flow lines  $\beta_i$  being traversed in the forward direction. By lemma 4.10,  $\{s_i, s'_i\}$  is the repelling set for the action of  $\gamma_i$  on  $\partial\mathcal{O}$  and  $\{t_i, t'_i\}$  is the attracting set.

Here  $\mathcal{O}^s(q_i)$  intersects  $l = \mathcal{O}^u(\alpha)$  and  $\mathcal{O}^u(\gamma_i(\alpha))$  for every  $i$ . As described above  $\gamma_i(l)$  converges to the unstable leaf  $r := \mathcal{O}^u(\Theta(\delta))$ . Since  $\mathcal{O}^u(\gamma_i(\alpha))$  converges and the length of  $\beta_i$  goes to infinity, then the arguments of case 2.c of the proof of theorem 4.11 show that the only possibility is that  $\mathcal{O}^u(q_i)$  converges to  $l = \mathcal{O}^u(\alpha)$  – otherwise  $l$  would be pushed farther and farther away from  $\mathcal{O}^u(q_i)$ . This shows that  $\tau$  is in  $L$  and  $s, s'$  are the ideal points of  $l$ . Up to renaming the ideal points of  $l$ ,  $z = s$ . Up to another subsequence assume that

$$s_i \rightarrow s, \quad s'_i \rightarrow s', \quad t_i \rightarrow t, \quad t'_i \rightarrow t'$$

Again the arguments in case 2.c of theorem 4.11 show that in  $\partial\mathcal{O}$ , we have  $\gamma_i | (\partial\mathcal{O} - \{s, s'\})$  converges locally uniformly to the set  $\{t, t'\}$ . Also  $\gamma_i(z)$  converges to a point  $d$  in  $\partial r$ . As  $z = s$  then  $x = \varphi(s)$  and we have in  $\mathcal{R}$  that  $\gamma_i | (\mathcal{R} - \{x\})$  converges locally uniformly to  $\varphi(t)$ . Since  $d$  is a unstable ideal point and  $t$  is a stable ideal point, it follows that  $\varphi(t) \neq \varphi(d)$ . Summing it all up:

$$\gamma_i(x) \rightarrow \varphi(d) \quad \text{and} \quad \gamma_i(y) \rightarrow \varphi(t) \quad \text{for any } y \in \mathcal{R} - \{x\}$$

This shows that  $x$  is a conical limit point.

**Remark** – Obviously it is crucial in this proof that  $z$  is an ideal point of a leaf of  $\mathcal{O}^s$  or  $\mathcal{O}^u$ . Since  $z$  is an unstable ideal point and we want to push points away from the unstable ideal point, then in the proof above we use  $\gamma_i$  associated to positive flow direction (recall lemma 4.10), while keeping track of what  $\gamma_i$  does to  $z$ . The only difference is that here we were careful to make sure  $\gamma_i(z)$  did not converge to a certain stable ideal point in the limit. This proof does not work at all in the case  $z$  is not ideal point of a leaf of  $\mathcal{O}^s$  or  $\mathcal{O}^u$ .

Case 3 –  $x = \varphi(z)$  where  $z$  is not ideal point of a leaf of  $\mathcal{O}^s$  or  $\mathcal{O}^u$ .

This case is much more interesting. Since  $z$  is not ideal point of a leaf of  $\mathcal{O}^s$  or  $\mathcal{O}^u$ , by proposition 3.33 there is a neighborhood system of  $z$  in  $\mathcal{D}$  defined by a sequence of stable leaves, which can be assumed to be all nonsingular. Let  $l_1$  be one of these leaves. The construction here will be inductive. Let  $W$  be the component of  $\mathcal{O} - l_1$  which has  $z$  in its closure. Let  $\partial l_1 = \{b_0, b_1\}$ . Let  $(b_0, z)$  be the interval of  $\partial\mathcal{O}$  contained in the closure of  $W$  in  $\mathcal{D}$  and similarly define  $(b_1, z)$ . Let  $s$  be a leaf of  $\mathcal{O}^u$  intersecting  $l_1$ . If  $s$  is near  $b_0$  then all ideal points of  $s$  are near  $b_0$  – by the escape lemma (lemma 4.4, part iii). If  $s$  is near  $b_1$  then all ideal points are near  $b_1$ . The ideal points of the prongs of  $s$  entering  $W$  vary monotonically in  $\partial\mathcal{O}$  as one moves  $s$  across  $l_1$ . Since no unstable leaf has ideal point  $z$  and the leaf space of  $\mathcal{O}^u$  is Hausdorff, then there is a single leaf – call it  $s_1$  intersecting  $l_1$  and having at least one prong contained in  $W$  with an ideal point in  $(b_0, z)$  and another prong with ideal point in  $(b_1, z)$ , see fig. 21, a. Let  $p_1$  be the singular

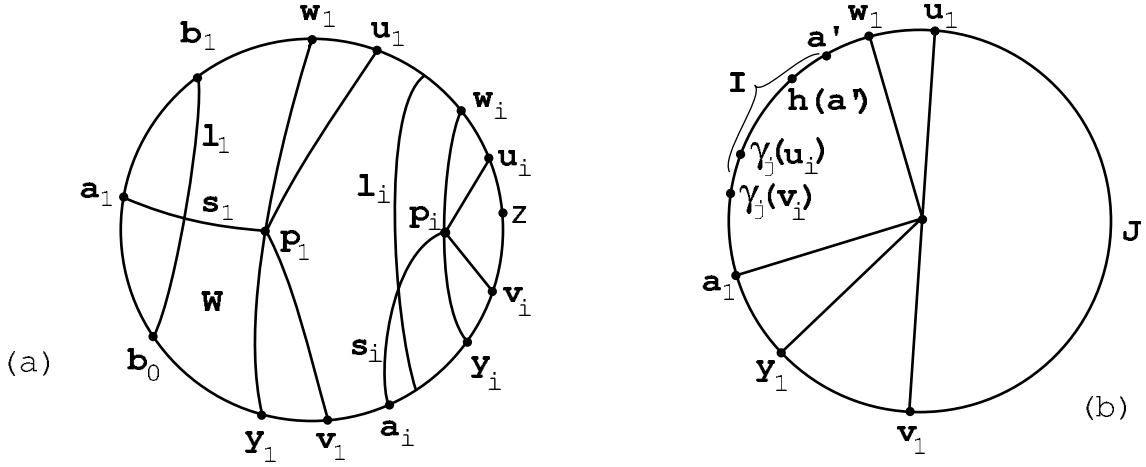

Figure 21: a. Splitting in the stable leaves, b. Mapping back to a compact region.

point in this leaf which has to be in  $W$ . Let  $v_1$  be the ideal point of  $\mathcal{O}^u(p_1)$  in  $(b_0, z)$  closest to  $z$  and  $u_1$  the one in  $(b_1, z)$  closest to  $z$ . Let  $a_1$  be the ideal point of the (unique) prong of  $\mathcal{O}^u(p_1)$  intersecting  $l_1$ .

We can now proceed inductively: assuming that  $l_{i-1}$  has been chosen and  $s_{i-1}, p_{i-1}$  have been constructed, let  $l_i$  be a stable leaf separating  $z$  from  $\mathcal{O}^u(p_{i-1})$ . As before construct  $s_i, p_i, u_i, v_i$ , see fig. 21, a. Let  $w_i$  be the ideal point of  $\mathcal{O}^s(p_i)$  in  $(u_i, b_1)$  closest to  $b_1$  and  $y_i$  the ideal point of  $\mathcal{O}^s(p_i)$  in  $(v_i, b_0)$  closest to  $b_0$  – do this also for  $i = 1$ . There are such points because  $\mathcal{O}^u(p_i)$  intersects  $l_i$  which is a stable leaf. Let  $a_i$  be the ideal point of the prong of  $\mathcal{O}^u(p_i)$  which intersects  $l_i$ .

We will now take subsequences at will and rename points and transformations, in order to simplify notation. Every  $p_i$  is singular, so up to subsequence assume the  $p_i$  are all translates of each other. Hence there are  $\gamma_i$  in  $\pi_1(M)$  with  $\gamma_i(p_i) = p_1$ . Up to another subsequence either every  $\gamma_i$  preserves orientation in  $\mathcal{O}$ , or every  $\gamma_i$  reverses orientation in  $\mathcal{O}$ . In the second case throw out  $p_1$  (that is start with  $p_2$  which will be renamed  $p_1$  and also rename the  $\gamma_i$  to have  $\gamma_i(p_i) = p_1$  for the new  $p_1$ , etc.). So we can assume that every  $\gamma_i$  preserves orientation in  $\mathcal{O}$ . Up to a further subsequence assume that  $\gamma_i(a_i) = a_1$  (where as before throw out initial terms and rename if necessary). Under these conditions, it now follows that  $\gamma_i(u_i) = u_1, \gamma_i(v_i) = v_1, \gamma_i(w_i) = w_1, \gamma_i(y_i) = y_1$ . Let  $(a_i, w_i)$  be the interval in  $\partial\mathcal{O}$  defined by  $a_i, w_i$  and not containing  $z$ . Assume also up to subsequence that for  $j > i$  then  $y_i, v_i, u_i, w_i$  are in  $(a_j, w_j)$ , see fig. 21, a. This is because there are 2 possibilities for the placement of  $a_j$ .

Since  $p_1$  is singular, let  $h$  be a generator of the isotropy group of  $p_1$  which leaves all prongs of  $\mathcal{O}^s(p_1)$  (and hence of  $\mathcal{O}^u(p_1)$ ) invariant. Ideally we would like to obtain transformations which send more and more of  $\partial\mathcal{O} - \{z\}$  to a compact set in  $(a_1, w_1)$ . However in order to simplify the argument and the notation with indices we will prove that this is true for a fixed compact set of  $\mathcal{O} - \{z\}$  and then use that and the convergence group property to show that  $\varphi(z)$  is a conical limit point. For each  $i$  let  $T_i$  be the closed interval of  $\partial\mathcal{O}$  defined by  $u_i, v_i$  and not containing  $z$ .

For the remainder of the proof we fix  $i$  very big and let  $C = T_i$  – this is almost all of  $\partial\mathcal{O} - \{z\}$ . Let  $a'$  be a point in  $(a_1, w_1)$ . By construction for any  $j$  then  $\gamma_j(u_j) = u_1, \gamma_j(a_j) = a_1$ . Let  $j > i$ . Since  $u_i$  is in  $(a_j, w_j)$  then  $\gamma_j(u_i)$  is in  $(a_1, w_1)$ . Now for each  $j > i$  there is a single  $n_j$  in  $\mathbf{Z}$  so that

$$h^{n_j}(\gamma_j(u_i)) \quad \text{is in} \quad [a', h(a')]$$

where  $[a', h(a')]$  is the subinterval of  $[a_1, w_1]$  bounded by these points. Suppose that  $w_1$  is a repelling fixed point of  $h$  (that is,  $h$  is associated to backwards flow direction). Since  $\gamma_j$  preserves orientation in  $\mathcal{D}$  then  $t_j = h^{n_j}(\gamma_j(v_i))$  is closer to  $a_1$  in  $[a_1, w_1]$  than  $h^{n_j}(\gamma_j(u_i))$  is. We claim that  $t_j$  is in a compact set  $I$  of  $(a_1, w_1)$  as  $j$  varies (in particular  $\gamma_j(C) \subset I$ ). Otherwise there are  $j$  with  $t_j$  arbitrarily close to  $a_1$ . Here



$$h^{n_j} \gamma_j(\mathcal{O}^u(p_i))$$

is an unstable leaf with a point in  $[a', h(a')]$  and another very close to  $a_1$ . Take a subsequence and find in the limit an unstable leaf  $\delta$  with an ideal point in  $[a', h(a')]$  and another in  $a_1$  – a consequence of the escape lemma (lemma 4.4, part iii). Since  $\delta$  is not  $\mathcal{O}^u(p_1)$  this would force the existence of perfect fits, contradiction. Hence there is a compact subinterval  $I$  in  $(a_1, w_1)$  with  $t_j$  always in  $I$ . We now define the transformations

$$g_j = h^{n_j} \gamma_j, \quad j > i \quad \text{hence} \quad g_j(C) \subset I.$$

Let  $J$  be the closed interval of  $\partial\mathcal{O}$  bounded by  $u_1, v_1$  and not containing  $a_1$ . Then  $g_j(z)$  is in  $J$  for any  $j \geq 2$  so up to a subsequence we may assume that  $g_j(z)$  converges to a point  $c$  in  $J$ .

We will show that there is a subsequence of  $(g_j)$  which proves that  $x$  is a conical limit point.

We first claim that  $\varphi(I), \varphi(J)$  are disjoint. Suppose that  $\varphi(I)$  intersects  $\varphi(J)$ . Then there has to be a leaf of  $\mathcal{O}^s$  or  $\mathcal{O}^u$  with ideal points in both  $I$  and  $J$ . Consider first the unstable case. The endpoints of  $J$  are ideal points of  $\mathcal{O}^u(p_1)$ . The other ideal points of  $\mathcal{O}^u(p_1)$  are not in  $I$  – by construction of the interval  $I$  in  $(a_1, w_1)$ . Any other leaf of  $\mathcal{O}^u$  either has all ideal points in  $J$  or has no ideal point in  $J$ . Hence no unstable leaf has ideal points in  $I$  and  $J$ .

Consider now stable leaves:  $\mathcal{O}^s(p_1)$  has one ideal point in  $J$  and all others in the interval of  $\partial\mathcal{O}$  defined by  $w_1, y_1$  and containing  $I$ . Hence  $\mathcal{O}^s(p_1)$  it does not have an ideal point in  $I$ . Let  $r$  be any other leaf of  $\mathcal{O}^s$ . If  $r$  has an ideal point in  $J$  then  $r$  is separated from the interval  $I$  by  $\mathcal{O}^s(p_1)$  – hence  $r$  cannot limit in  $I$ . We conclude that  $\varphi(I), \varphi(J)$  are 2 disjoint compact subsets of  $\mathcal{R}$ .

Recall that  $(g_n(z))$  converges to  $c$  and  $x = \varphi(z)$ . Hence in  $\mathcal{R}$  the sequence  $(g_n(x))$  converges to  $\varphi(c) \in \varphi(J)$ . In theorem 4.11 we have already shown that  $\pi_1(M)$  acts as a convergence group on  $\mathcal{R}$ , so assume up to subsequence that  $(g_n)$  has a source/sink pair (for notational simplicity we still denote this subsequence by  $(g_n)$ ). That means there are  $a, b \in \mathcal{R}$  so that  $g_n(A)$  converges to  $b$  for any compact set  $A$  of  $\mathcal{R} - \{a\}$ . In particular if we find three distinct points  $d_1, d_2, d_3$  of  $\mathcal{R}$  so that  $g_n(d_1), g_n(d_2)$  converge to  $e_1$  and  $g_n(d_3)$  converges to  $e_2$  with  $e_1 \neq e_2$ , then  $d_3$  is the source and  $e_1$  is the sink.

The image  $\varphi(C)$  contains infinitely many points, so take 3 distinct points  $d_0, d_1, d_2$  in  $\varphi(C)$ . By the above, for at least two of these points the sequence  $(g_n(d_k))$  converges. So assume wlog that  $(g_n(d_1)), (g_n(d_2))$  converge – the limit is in  $\varphi(I)$ . The sequence  $(g_n(x))$  also converges and the limit is in  $\varphi(J)$ . As  $\varphi(I), \varphi(J)$  are disjoint, it follows that the limits of  $(g_n(d_1)), (g_n(d_2))$  have to be the same point  $t$ . By the previous paragraph  $t$  is the sink and  $x$  is the source for the sequence  $(g_n)$  acting on  $\mathcal{R}$ . Since  $t \in \varphi(I), x \in \varphi(J)$  it follows that  $t \neq x$ . Hence the sequence  $(g_n)$  of  $\pi_1(M)$  shows that  $x$  is a conical limit point.

This shows that all points of  $\mathcal{R}$  are conical limit points for the action of  $\pi_1(M)$ . Hence  $\pi_1(M)$  acts as a uniform convergence group in  $\mathcal{R}$ . This finishes the proof of theorem 4.12.  $\square$

We now analyse the space  $\widetilde{M} \cup \mathcal{R}$ . We first establish some notation. Let

$$\eta: \mathcal{D} \times [-1, 1] \rightarrow \widetilde{M} \cup \mathcal{R}$$

be the projection map. Recall also the sphere filling map  $\varphi: \partial\mathcal{O} \rightarrow \mathcal{R}$ . We consider the quotient topology in  $\widetilde{M} \cup \mathcal{R}$ . Let  $\mathcal{T}$  be this topology. Recall that  $\partial(\mathcal{D} \times [-1, 1])$  is a sphere, let  $\eta_1 = \eta|_{\partial(\mathcal{D} \times [-1, 1])}$ . With the subspace topology from  $\mathcal{T}$ , then  $\mathcal{R}$  is a sphere also. We stress that in all arguments here we implicitly identify  $\widetilde{M}$  with  $\mathcal{O} \times (-1, 1)$  and in particular also think of  $\widetilde{M}$  as a subset of  $\mathcal{D} \times [-1, 1]$ .

Notice that  $\pi_1(M)$  naturally acts on  $\widetilde{M} \cup \mathcal{R}$  by homeomorphisms as it preserves stable and unstable foliations. Our main goal to finish this section is to show that this action is a convergence group action.

One problem is that it is hard to verify directly whether a set in  $\widetilde{M} \cup \mathcal{R}$  is open or not. To make it more explicit we define another topology  $\mathcal{T}'$  in  $\widetilde{M} \cup \mathcal{R}$  and then show it is the same as the quotient

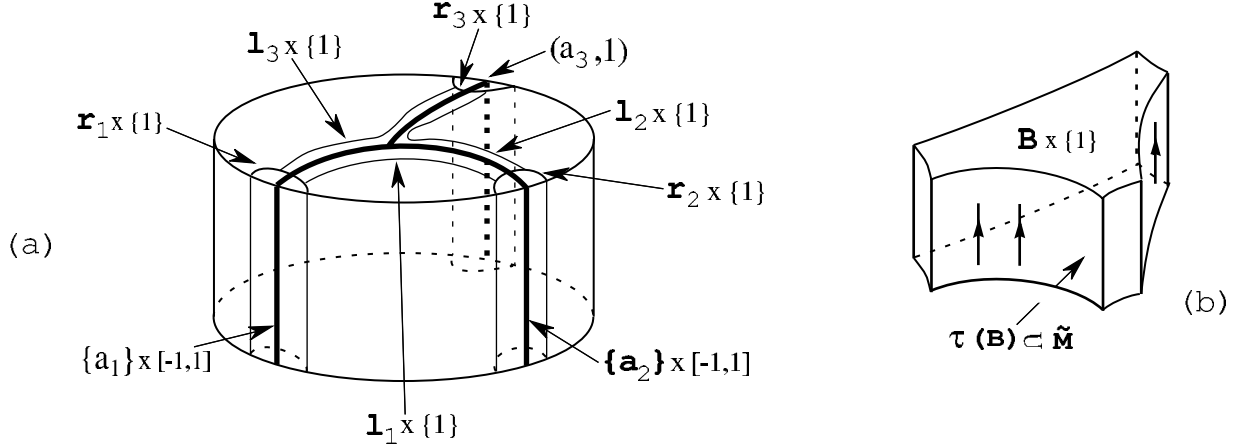

Figure 22: a. The neighborhoods of certain points, b. Flow forward of sections.

topology. The new topology will be defined using neighborhood systems. Recall [Ke] chapter 1 that a neighborhood system  $\mathcal{U}_x$  of a point  $x$  is a collection satisfying:

- 1) If  $U$  is in  $\mathcal{U}_x$  then  $x$  is in  $U$ .
- 2) If  $U, V$  are in  $\mathcal{U}_x$  then  $U \cap V$  is in  $\mathcal{U}_x$ .
- 3) If  $U$  in  $\mathcal{U}_x$  and  $U \subset V$  then  $V$  is in  $\mathcal{U}_x$ .

Define  $U$  to be open if  $U$  is a neighborhood of any of its points. This defines a topology in the space.

**Definition 4.13.** (neighborhood systems in  $\widetilde{M} \cup \mathcal{R}$ ) Let  $\Phi$  be a pseudo-Anosov flow without perfect fits and not topologically conjugate to suspension Anosov.

i) If  $x$  is in  $\widetilde{M}$  then  $V$  is in  $\mathcal{U}_x$  if  $V$  contains an open set of  $\widetilde{M}$  (with its usual topology) containing  $x$ ,  
 ii) Let  $x$  in  $\mathcal{R}$  so that  $\varphi^{-1}(x) = \{b\}$ , a single point. The point  $b$  of  $\partial\mathcal{O}$  is not identified to any other point of  $\partial\mathcal{O}$ , hence  $b$  is not an ideal point of a leaf of  $\mathcal{O}^s$  or  $\mathcal{O}^u$ . In this case  $b$  has a neighborhood system in  $\mathcal{D}$  defined by sequences of nonsingular stable or unstable leaves. Let  $l$  be one such leaf and  $U_l$  the corresponding open set of  $\mathcal{D}$ , as in definition 3.18, where  $b$  is in  $U_l$ . Let  $V_l = U_l \times [-1, 1]$  a subset of  $\mathcal{D} \times [-1, 1]$ . We say that  $V$  is in  $\mathcal{U}_x$  if for some  $l$  as above then  $V_l \subset \eta^{-1}(V)$ . Notice  $\eta^{-1}(V)$  is a subset of  $\mathcal{D} \times [-1, 1]$ .

iii) Let  $x$  in  $\mathcal{R}$  with  $\varphi^{-1}(x) = \{a_1, \dots, a_n\}$ . For simplicity assume that  $a_1, \dots, a_n$  are the ideal points of a stable leaf  $l$ . Let  $g$  be the cellular decomposition element of  $\mathcal{R}$  of  $\partial(\mathcal{D} \times [-1, 1])$  associated to  $l$  (that is  $g = l \times \{1\} \cup \cup_i (\{a_i\} \times [-1, 1])$  or equivalently  $g$  is identified to the point  $x$ ). For each  $i$ , choose  $r_i$  unstable leaves defining small neighborhoods of  $a_i$  in  $\mathcal{D}$ . Let  $V_{r_i} = U_{r_i} \times [-1, 1]$  as in ii), where  $a_i$  is in  $U_{r_i}$ .

Let  $l_1, \dots, l_n$  stable leaves ( $\mathcal{O}^s$ ) very near each line leaf of  $l$  and so that for each  $i$ , then  $l_i, l_{i+1}$  intersect  $r_i$  transversely ( $i \bmod i_0$ ). Then  $l_1, \dots, l_n, r_1, \dots, r_n$  bound a compact region  $B$  in  $\mathcal{O}$ . Choose any section  $\tau : B \rightarrow \widetilde{M}$  of  $\Theta$  restricted to  $B$ . Let  $H_\tau$  be the union of  $B \times \{1\}$  together with the set of points  $w$  in  $\widetilde{M}$  (or in  $\mathcal{O} \times (-1, 1)$ ) with  $w = \widetilde{\Phi}_t(b)$  for some  $b$  in  $\tau(B)$  and  $t \geq 0$ . Let  $\delta$  denote the collection  $(l_1, \dots, l_n, r_1, \dots, r_n, \tau)$ . We use the notation  $A_\delta$  to denote the following:

$$A = A_\delta = A(l_1, \dots, l_n, r_1, \dots, r_n, \tau) = H_\tau \cup V_{r_1} \cup \dots \cup V_{r_n}$$

Let  $\mathcal{U}_x$  be the collection of the sets  $Z$  so that for some  $\delta$  as above then  $A_\delta \subset \eta^{-1}(Z)$ .

In the case of ideal points of unstable leaves, one switches stable and unstable objects and chooses points flow backwards from a section and backward ideal points.

**Lemma 4.14.** The collection  $\mathcal{U}_x$  for  $x$  in  $\widetilde{M} \cup \mathcal{R}$  defines a neighborhood system and consequently a topology  $\mathcal{T}^l$  in  $\widetilde{M} \cup \mathcal{R}$ .

*Proof.* For  $x$  in  $\widetilde{M}$  this is clear. In the other 2 cases it is easy to see that properties 1) and 3) of neighborhood systems always hold: 3) is obvious by definition and 1) holds because the cell decomposition elements (in  $\partial(\mathcal{D} \times [-1, 1])$ ) are always contained in the sets  $V_l$  or  $A_\delta$ .

We now check property 2). Suppose first that  $x$  is of type ii). Let  $x = \varphi(b)$ . Let  $V_1, V_2$  in  $\mathcal{U}_x$ , with  $V_1$  defined by  $l$  and  $V_2$  defined by  $r$  leaves of  $\mathcal{O}^s$  or  $\mathcal{O}^u$ . Then there is  $l'$  in  $\mathcal{O}^s$  or  $\mathcal{O}^u$  so that  $l' \cup \partial l'$  separates  $b$  from  $r \cup l$  in  $\mathcal{D}$ . Then  $U_{l'}$  is contained in  $U_l \cap U_r$  and we are done.

Let now  $x$  of type iii). Let  $U_1, U_2$  be neighborhoods of  $x$ , where  $U_i$  contains  $A_i$  of the form  $A_i = A(l_1^i, \dots, l_n^i, r_1^i, \dots, r_n^i, \tau_i)$  as in definition 4.13, so that for each  $i$ ,  $l_1^i, l_n^i$  are close to the same line leaf of  $l$  and  $r_1^i, r_n^i$  define small neighborhoods of  $a_i$ . Choose  $l_i^3$  closer to  $l$  than both  $l_1^i$  and  $l_n^i$  and  $r_i^3$  closer to  $a_i$  than both  $r_1^i$  and  $r_n^i$ . Let  $B_3$  be the compact region of  $\mathcal{O}$  defined by the  $l_i^3, r_i^3$ . Choose a section  $\tau_3$  in  $B_3$  so that in the intersection  $B_3 \cap (B_1 \cup B_2)$  then  $\tau_3$  is greater than  $\max(\tau_1, \tau_2)$ . Then  $A_3 = A(l_1^3, \dots, l_n^3, r_1^3, \dots, r_n^3, \tau_3)$  is in  $\mathcal{U}_x$  and  $A_3 \subset A_1 \cap A_2 \subset U_1 \cap U_2$ . Hence  $\mathcal{U}_x$  is a neighborhood system for  $x$  in  $\widetilde{M} \cup \mathcal{R}$ .

Therefore the collection  $\{\mathcal{U}_x, x \in \widetilde{M} \cup \mathcal{R}\}$  defines a topology in  $\widetilde{M} \cup \mathcal{R}$ .  $\square$

**Lemma 4.15.** *The quotient topology  $\mathcal{T}$  in  $\widetilde{M} \cup \mathcal{R}$  and the neighborhood system topology  $\mathcal{T}'$  are the same topology. This implies that the quotient topology in  $\mathcal{R}$  and the subspace topology from  $\mathcal{T}'$  in  $\mathcal{R}$  are also the same topology.*

*Proof.* First let  $U$  in  $\mathcal{T}'$  and let  $x$  in  $U$ . If  $x$  is in  $\widetilde{M}$ , then (i) of definition 4.13 shows that there is  $V$  open in (usual topology) of  $\widetilde{M}$  with  $x \in V \subset U$ . If  $x$  is in  $\mathcal{R}$  let  $g = \eta^{-1}(x)$ . By construction if  $x$  is of type ii) or iii) as in definition 4.13, then  $\eta^{-1}(U)$  contains an open set in  $\mathcal{D} \times [-1, 1]$  which contains  $g$ . This shows that  $\eta^{-1}(U)$  is an open set in  $\mathcal{D} \times [-1, 1]$  and hence  $U$  is in  $\mathcal{T}$ .

Conversely let  $U$  in  $\mathcal{T}$ . Then  $\eta^{-1}(U)$  is open in  $\mathcal{D} \times [-1, 1]$ . Let  $x$  in  $U$ . If  $x$  is in  $\widetilde{M}$ , then  $x$  is in the open set  $\eta^{-1}(U) \cap \widetilde{M} \subset \eta^{-1}(U)$  so  $\eta^{-1}(U)$  is in  $\mathcal{U}_x$ .

Suppose then that  $x$  is in  $\mathcal{R}$  and let  $g$  the cell element of  $\mathcal{R}$  associated to  $x$ . For simplicity we assume that  $x$  is of type iii) in definition 4.13, as type ii) is analogous and easier to deal with. Let  $l$  (as in part iii) of def. 4.13) be the leaf of (say)  $\mathcal{O}^s$  with  $l \times \{1\}$  a subset of  $g$ . Then  $\eta^{-1}(U)$  is an open set in  $\mathcal{D} \times [-1, 1]$  containing  $g$ . For any ideal point  $b$  of  $l$ , then  $\eta^{-1}(U)$  contains an open neighborhood of  $b \times [-1, 1]$  in  $\mathcal{D} \times [-1, 1]$ . Since  $b$  is a stable ideal point, there is an unstable leaf  $z$  defining a small neighborhood of  $b$  in  $\mathcal{D}$  so that  $V_z \subset \eta^{-1}(U)$ . We also consider for each line leaf of  $l$  a regular leaf  $e$  of  $\mathcal{O}^s$  close to this line leaf. Choose each  $e$  sufficiently close to  $l$  so that these  $e$ 's and the  $z$ 's as above define a compact polygon  $B$  in  $\mathcal{O}$ . As  $\eta^{-1}(U)$  is open and contains  $l \times \{1\}$ , it follows that if the  $e$ 's are sufficiently close to  $l$  and the  $z$ 's sufficiently close to  $\partial l$ , then  $B \times \{1\} \subset \eta^{-1}(U)$ . As  $B$  is compact, there is a high enough section  $\tau : B \rightarrow \widetilde{M}$  so that  $H_\tau \subset \eta^{-1}(U)$ . This shows that  $\eta^{-1}(U)$  contains one set of form  $A_\delta$  as in iii) of definition 4.13 and so  $U$  is in  $\mathcal{U}_x$ . Since  $U$  is in  $\mathcal{U}_x$  for any  $x$  in  $U$ , it follows that  $U$  is open with respect to  $\mathcal{T}'$ . Hence  $\mathcal{T}$  is equal to  $\mathcal{T}'$ .  $\square$

**Lemma 4.16.** *The space  $\widetilde{M} \cup \mathcal{R}$  is compact.*

*Proof.* Let  $\{Z_\alpha\}_{\alpha \in \mathcal{I}}$  be an open cover of  $\widetilde{M} \cup \mathcal{R}$ . This provides an open cover of  $\mathcal{R}$  which is compact. Hence there is a finite subcollection  $Z_{\alpha_1}, \dots, Z_{\alpha_n}$  whose union contains  $\mathcal{R}$ . Then

$$C = \widetilde{M} \cup \mathcal{R} - \left( \bigcup_{i=1}^n Z_{\alpha_i} \right) \subset \widetilde{M}$$

is closed. Since the topology in  $\widetilde{M}$  is the same as the induced topology from  $\widetilde{M} \cup \mathcal{R}$ , it follows that  $C$  is closed in  $\widetilde{M}$  and hence compact and it has a finite subcover. This finishes the proof.  $\square$

Here is another way to see that  $\pi_1(M)$  acts on  $\widetilde{M} \cup \mathcal{R}$ : Let  $\gamma$  in  $\pi_1(M)$ . Then  $\gamma$  takes sets of the form  $V_l$  (of (ii) of definition 4.13) for  $l$  in  $\mathcal{O}^s$  or  $\mathcal{O}^u$  to  $V_{\gamma(l)}$ . Sections  $\tau : B \rightarrow \widetilde{M}$  over compact sets  $B$  in  $\mathcal{O}$  are taken to sections over compact sets  $\gamma(B)$  by  $\gamma$ . Hence  $\pi_1(M)$  preserves the collection of sets described in

ii), iii) of definition 4.13. Therefore  $\gamma$  takes neighborhoods  $\widetilde{M} \cup \mathcal{R}$  to neighborhoods and consequently  $\pi_1(M)$  acts by homeomorphisms on  $\widetilde{M} \cup \mathcal{R}$ .

We stress that it is hard to find open sets in  $\widetilde{M} \cup \mathcal{R}$  explicitly: for example if  $l$  is a nonsingular leaf of  $\mathcal{O}^s$ , with corresponding open set  $V_l$  in  $\mathcal{D} \times [-1, 1]$ , it is not true that  $\eta(V_l)$  is open in  $\widetilde{M} \cup \mathcal{R}$ , because  $V_l$  is not saturated by the equivalence relation defining the quotient: Certainly  $V_l \cap \widetilde{M}$  is open in  $\widetilde{M}$  and  $V_l \cap (\mathcal{D} \times \{1\})$  is both open and saturated in  $\mathcal{D} \times \{1\}$ . However  $V_l \cap (\mathcal{D} \times \{-1\})$  is not saturated. Take any leaf  $s$  of  $\mathcal{O}^u$  intersecting  $l$ . Then  $s \times \{-1\}$  intersects  $V_l$  but is not contained in  $V_l$ . Those leaves  $s \times \{-1\}$  would have to be contained in a saturation of  $V_l$ . But their ideal points propagate through  $\partial\mathcal{O} \times [-1, 1]$  and then propagate in the top  $\mathcal{D} \times \{1\}$  through stable leaves.

**Lemma 4.17.** *The space  $\widetilde{M} \cup \mathcal{R}$  is first countable.*

*Proof.* We only need to check this for  $x$  in  $\mathcal{R}$  since  $\widetilde{M}$  is a manifold and is open in  $\widetilde{M} \cup \mathcal{R}$ . Suppose  $\varphi^{-1}(x) = \{a_1, \dots, a_{i_0}\}$ , all ideal points of a stable leaf  $l$ . The other cases are either similar or simpler. For each  $1 \leq i \leq i_0$ , we will construct a nested sequence of unstable leaves  $(s_i^n)_{n \in \mathbb{N}}$  forming a master sequence defining  $a_i$ . For each line leaf  $l_i$  of  $l$  we will construct a nested sequence of nonsingular stable leaves  $(l_i^n)_{n \in \mathbb{N}}$  converging to  $l_i$  in that sector of  $l$ . Suppose that  $l_i^n, l_{i+1}^n$  ( $i \bmod(i_0)$ ) bound a small segment  $T_i^n$  in  $\partial\mathcal{O}$  containing  $a_i$  in its interior. We do the construction so that for all  $n$  and  $i$ , the leaves  $l_i^n, l_{i+1}^n$  intersect  $s_i^n$  transversely. Then for each  $n$

$$l_1^n, \dots, l_{i_0}^n, s_1^n, \dots, s_{i_0}^n$$

defines a compact set  $B_n$  in  $\mathcal{O}$ . It is not true that  $B_j \subset B_i$  if  $j > i$ . Fix a section  $\tau_1 : B_1 \rightarrow \widetilde{M}$ . We will choose sections  $\tau_n : B_n \rightarrow \widetilde{M}$  so that for each  $n$ ,  $\tau_n(B_{n-1} \cap B_n)$  is flow forward of  $\tau_{n-1}(B_{n-1} \cap B_n)$  and the flow length from  $\tau_1(B_n \cap B_1)$  to  $\tau_n(B_n \cap B_1)$  goes to infinity uniformly in  $n$ .

Let  $A_n = A(l_1^n, \dots, l_{i_0}^n, r_1^n, \dots, r_{i_0}^n, \tau_n)$ . Notice that  $\eta(A_n)$  is not open in  $\widetilde{M} \cup \mathcal{R}$  because  $A_n$  is not saturated. However we will choose  $A_n$  inductively so that there is an open set  $U_n$  in  $\widetilde{M} \cup \mathcal{R}$  satisfying

$$\eta(A_{n-1}) \supset U_n \supset \eta(A_n)$$

Here is the construction. Suppose that  $l_1^{n-1}, \dots, l_{i_0}^{n-1}, s_1^{n-1}, \dots, s_{i_0}^{n-1}$  have been chosen. We choose one set  $l_i^n, 1 \leq i \leq i_0$  closer to  $l$  than  $l_i^{n-1}$  and  $s_i^n$  closer to  $a_i$  than  $s_i^{n-1}$ . We will adjust these choices as needed.

Let  $x$  in  $\eta(A_n)$ . Certainly we can choose the section  $\tau_n$  so that if  $x$  is in  $\eta(A_n)$  and  $x$  is in  $\widetilde{M}$  then  $x$  is in the interior of  $\eta(A_{n-1})$ . Therefore assume that  $x$  is in  $\mathcal{R}$  and let  $y$  in  $\eta^{-1}(x)$ . There are 3 possibilities:

A) First suppose that  $y$  is in  $\mathcal{O} \times \{-1\}$ .

Then  $y$  is in the region of  $\mathcal{D} \times \{-1\}$  bounded by some  $s_i^n \times \{-1\}$ , which is strictly smaller than the region bounded by  $s_i^{n-1} \times \{-1\}$ . Let  $v$  be the leaf of  $\mathcal{O}^u$  with  $y$  in  $v \times \{-1\}$ . Then  $v$  is contained in the region  $U_{s_i^{n-1}}$  and hence there is a set  $A_\delta$  as in (iii) of definition 4.13 associated to  $v$  and so that

$$A_\delta \subset U_{s_i^{n-1}} \subset A_{n-1}$$

By definition  $\eta(A_{n-1})$ , is in  $\mathcal{U}_x$  because

$$\eta^{-1}(\eta(A_{n-1})) \supset A_{n-1} \supset A_\delta$$

B) The second case is that  $y$  is in  $\partial\mathcal{O} \times [-1, 1]$ , but  $y$  is not equivalent to any point in  $\mathcal{O} \times \{1\}$  or  $\mathcal{O} \times \{-1\}$  – that is,  $y$  does not come from an ideal point of a leaf of  $\mathcal{O}^s$  or  $\mathcal{O}^u$ . Then  $y$  is in some  $V_{s_i^n}$  and by part (ii) of definition 4.13,  $\eta(A_{n-1})$  is a neighborhood of  $x$  in  $\widetilde{M} \cup \mathcal{R}$ .

C) Finally suppose that  $y$  is in  $\mathcal{O} \times \{1\}$ .

If  $y$  is in the region of  $\mathcal{D}$  bounded by the  $l_i^n, 1 \leq i \leq i_0$ , then the proof as in part A) applies. The last case to analyse is  $y$  is  $V_{s_i^n}$  for some  $i$ . Here  $y$  is in  $u \times \{1\}$  with  $u$  leaf of  $\mathcal{O}^s$ . In this case we adjust  $s_i^n$  so that its endpoints are in the open interval  $T_i^{n-1}$ . Then all stable leaves near  $u$  are in the region bounded by  $l_i^{n-1}, l_{i+1}^{n-1}$ . This shows that  $\eta(A_{n-1})$  is a neighborhood of  $x = \eta(y)$ .

The modification in part C) makes the  $U_{s_i^n}$  smaller and hence one has to rechoose the  $l_i^n$  closer to  $l$  accordingly so that  $s_i^n$  intersects both  $l_i^n$  and  $l_{i+1}^n$ . With this modification it follows that  $\eta(A_{n-1})$  is a neighborhood of any point  $x$  in  $\eta(A_n)$  so there is an open set  $U_n$  in  $\widetilde{M} \cup \mathcal{R}$  with  $\eta(A_{n-1}) \supset U_n \supset \eta(A_n)$ .

As the sequence  $(l_i^n)$  converges to a line leaf of  $l$  for each  $i$ ,  $(s_i^n)$  converges to  $a_i$  and  $\tau_n(B_n)$  escapes in the positive direction, then it is now clear that the collection  $\{U_n\}_{n \in \mathbf{N}}$  forms a countable basis for the topology of  $\widetilde{M} \cup \mathcal{R}$  at  $x$ .  $\square$

This result will be used in section 5.

Finally we show that the action of  $\pi_1(M)$  on  $\widetilde{M} \cup \mathcal{R}$  is a convergence group action. The description of the topology in  $\widetilde{M} \cup \mathcal{R}$  using neighborhood systems is extremely useful for this result.

**Theorem 4.18.** *Let  $\Phi$  be a pseudo-Anosov flow without perfect fits and not conjugate to a suspension Anosov flow. Then the induced action of  $\pi_1(M)$  on  $\widetilde{M} \cup \mathcal{R}$  is a convergence group action.*

*Proof.* Let  $(\gamma_n)_{n \in \mathbf{N}}$  be a sequence of distinct elements in  $\pi_1(M)$ . Since the action of  $\pi_1(M)$  on  $\mathcal{R}$  is a convergence group action, then up to subsequence we can assume there are  $x, y$  in  $\mathcal{R}$  with  $(\gamma_n)$  converging locally uniformly to  $x$  in  $\mathcal{R} - \{y\}$ . We want to show that  $(\gamma_n)$  converges locally uniformly to  $x$  when acting on  $(\widetilde{M} \cup \mathcal{R}) - \{y\}$ . Let  $C$  be a compact set in  $\widetilde{M} \cup \mathcal{R} - \{y\}$ . Recall the surjective map  $\varphi : \partial\mathcal{O} \rightarrow \mathcal{R}$ .

Case 1 –  $\varphi^{-1}(y) = \{e\}$  – a single point.

Then  $\eta^{-1}(y)$  is a vertical segment in  $\partial\mathcal{O} \times I$ . For any neighborhood  $U$  of  $y$  in  $\widetilde{M} \cup \mathcal{R}$ , there is  $l$  an unstable (or stable) leaf defining a small neighborhood of  $e$  in  $\mathcal{D}$  so that  $V_l \subset \eta^{-1}(U)$ ,  $V_l$  as in definition 4.13. If  $C$  is disjoint from  $U$  then

$$\eta^{-1}(C) \subset \mathcal{D} \times I - V_l$$

Let  $Z$  be the closure of the segment of  $(\partial\mathcal{O} - \partial l)$  not containing  $e$  (this is almost all of  $\partial\mathcal{O}$ ). By the source/sink property of  $y, x$  for the sequence  $(\gamma_n)$  acting on  $\mathcal{R}$ , the set  $\gamma_n(Z)$  is very near  $\varphi^{-1}(x)$  for  $n$  big. As  $\gamma_n(Z)$  is a segment in  $\partial\mathcal{O}$ , then there is a single point  $b$  in  $\varphi^{-1}(x)$  with  $\gamma_n(Z)$  near  $b$  for  $n$  big. It follows that  $\gamma_n(\mathcal{D} \times I - V_l)$  is very near  $\{b\} \times [-1, 1]$  in  $\mathcal{D} \times [-1, 1]$  and so  $\gamma_n(\eta^{-1}(C))$  is very near  $\{b\} \times [-1, 1]$  in  $\mathcal{D} \times [-1, 1]$ . We conclude that  $\gamma_n(C)$  is very near  $x = \eta(\{b\} \times [-1, 1])$  in  $\widetilde{M} \cup \mathcal{R}$  as desired. This finishes the analysis of case 1.

Case 2 –  $\varphi^{-1}(y) = \{a_1, \dots, a_{i_0}\}$ , with  $i_0 \geq 2$ .

Suppose for simplicity that  $\{a_1, \dots, a_{i_0}\}$  are the ideal points of  $\mathcal{O}^s(p) = l$  for some  $p$  in  $\mathcal{O}$ . Let  $C$  be a compact set in  $\widetilde{M} \cup \mathcal{R} - \{y\}$ . As before there are  $\{l_i\}_{1 \leq i \leq i_0}$  regular leaves of  $\mathcal{O}^s$  very near the line leaves of  $l$  and there are  $\{r_i\}_{1 \leq i \leq i_0}$ , regular leaves of  $\mathcal{O}^u$  defining small neighborhoods of  $a_i$  so that the  $l_i$ 's together with the  $r_i$ 's define a compact set  $B$  in  $\mathcal{O}$  and there is a section  $\tau : B \rightarrow \widetilde{M}$  with

$$A = A(l_1, \dots, l_{i_0}, r_1, \dots, r_{i_0}, \tau) \quad \text{and so that} \quad \eta^{-1}(C) \subset \mathcal{D} \times [-1, 1] - A$$

Assume that  $r_i$  intersects  $l_i, l_{i+1} \pmod{i_0}$  and has ideal points near  $a_i$ . Since  $r_i, l_i$  are regular we need to be careful. Let  $\widetilde{r}_i$  be the component of  $\mathcal{O} - r_i$  which has  $a_i$  in its closure (in  $\mathcal{D} = \mathcal{O} \cup \partial\mathcal{O}$ ). Let also  $\widetilde{l}_i$  be the component of  $\mathcal{O} - l_i$  not containing the other  $l_j$ . Then consider the sets  $U_{r_i}$  and  $U_{l_i}$  as in definition 3.18. The endpoints of  $l_i$  bound a closed interval  $I_i$  in  $\partial\mathcal{O}$  contained in the closure of  $U_{l_i}$  (they do not contain any  $a_j$ ). Similarly the endpoints of  $r_i$  bound a very small closed interval  $J_i$  in  $\partial\mathcal{O}$  containing  $a_i$ . As in definition 4.13, let  $V_{r_i} = U_{r_i} \times [-1, 1]$  and let  $H_\tau = \{\widetilde{\Phi}_t(z) \mid z \in \tau(B) \text{ and } t \geq 0\} \cup (B \times \{1\})$ . The sets  $C$  and  $A$  will be fixed for the rest of the proof of case 2.

Let  $\varphi^{-1}(x) = \{b_1, \dots, b_{j_0}\}$ .

**Case 2.a** – The union  $\cup_i \gamma_n(\partial l_i)$  is eventually (with  $n$ ) always very near a single point  $b_1$  in  $\varphi^{-1}(x)$ .

Since  $\gamma_n$  restricted to compact sets of  $(\partial\mathcal{O} - \varphi^{-1}(y))$  has image very close to  $\varphi^{-1}(x)$  for  $n$  big, it follows that for all  $i$ ,  $1 \leq i \leq i_0$  then  $\gamma_n(I_i)$  is very close to  $b_1$  in  $\mathcal{D}$ . This implies that  $\gamma_n(V_i)$  is very close to  $\{b_1\} \times [-1, 1]$  in  $\mathcal{D} \times [-1, 1]$ . In addition since the  $\gamma_n$  are homeomorphisms of  $\partial\mathcal{O}$ , then there is a single  $i$  (assume for simplicity that  $i = 1$ ) so that  $\gamma_n(J_1)$  is almost all of  $\partial\mathcal{O}$  and hence  $\gamma_n(\partial\mathcal{O} - J_1)$  is very close to  $b_1$ . Notice that

$$\mathcal{D} \times [-1, 1] - (H_\tau \cup V_{r_1} \cup \dots \cup V_{r_n}) \subset \mathcal{D} \times [-1, 1] - V_{r_1}$$

By the above  $\gamma_n(\mathcal{D} \times [-1, 1] - V_{r_1})$  is very close to  $\{b_1\} \times [-1, 1]$  in  $\mathcal{D} \times [-1, 1]$ . It follows that  $\gamma_n(C)$  is very close to  $x$  for  $n$  big. This finishes the analysis in this case.

**Case 2.b** – The union  $\cup_i \gamma_n(\partial l_i)$  gets closer to more than one point in  $\varphi^{-1}(x)$ .

We first explain why the  $b_i$  are ideal points of an unstable leaf in this case. To start we claim that, for a single  $i$ , the ideal points of  $\gamma_n(l_i)$  are close to a single point in  $\varphi^{-1}(x)$  for  $n$  big. Let  $c_1, c_2$  be the endpoints of  $l_i$ . If the claim is not true, then up to subsequence the sequences  $(\gamma_n(c_1)), (\gamma_n(c_2))$  converge to two distinct points  $d_1, d_2$  in  $\varphi^{-1}(x)$ . It follows that  $\gamma_n(U_{l_i} \cap \partial\mathcal{O})$  contains most of a segment with endpoints  $d_1, d_2$ . This contradicts the fact that  $\gamma_n(U_{l_i} \cap \partial\mathcal{O})$  converges to points in  $\varphi^{-1}(x)$ . This proves the claim.

The hypothesis of case 2.b implies that there is some  $i$  so that the ideal points of  $\gamma_n(l_i), \gamma_n(l_{i+1})$  are not close. But  $\gamma_n(r_i)$  intersects both of these leaves, hence the escape lemma implies that up to subsequence  $(\gamma_n(r_i))$  converges to a leaf  $s$  of  $\mathcal{O}^u$ . The source/sink property for  $y, x$  implies that the ideal points of  $\gamma_n(r_i)$  have to be getting close to points in  $\varphi^{-1}(x)$ . It follows that  $\varphi^{-1}(x) = \partial s$  with  $s$  an unstable leaf, as we desired to show.

For any neighborhood  $W$  of  $x$  in  $\widetilde{M} \cup \mathcal{R}$  there is a set  $D$  in  $\mathcal{D} \times [-1, 1]$  as in definition 4.13:  $D$  is defined by  $s_1, \dots, s_{j_0}$  regular leaves of  $\mathcal{O}^u$  near line leaves of  $s$ ; also  $t_1, \dots, t_{j_0}$  regular leaves of  $\mathcal{O}^s$ , where  $t_j$  defines a small neighborhood  $U_{t_j}$  of  $b_j$  in  $\mathcal{D}$ . The  $s_j, t_j, 1 \leq j \leq j_0$  jointly bound a compact set  $B'$  in  $\mathcal{O}$ , consider a section  $\nu : B' \rightarrow \widetilde{M}$  and  $E_\nu$  the set of points flow backwards from  $\nu(B')$  union  $B' \times \{-1\}$ :

$$E_\nu = \widetilde{\Phi}_{(-\infty, 0]}(\nu(B')) \cup (B' \times [-1, 1])$$

Let

$$D = D(s_1, \dots, s_{j_0}, t_1, \dots, t_{j_0}, \nu) = \left( \bigcup_{1 \leq j \leq j_0} V_{t_j} \right) \cup E_\nu$$

Then there is such a  $D$  so that  $D \subset \eta^{-1}(W)$ . Fix one such  $D$ . We want to show that  $\gamma_n(C)$  is eventually contained in  $W$  in  $\widetilde{M} \cup \mathcal{R}$ . It suffices to show that  $\gamma_n(\mathcal{D} \times [-1, 1] - A) \subset D$  in  $\mathcal{D} \times [-1, 1]$ . In case 2.b an argument in  $\widetilde{M}$  will be needed. For the fixed  $B$  as above with section  $\tau : B \rightarrow \widetilde{M}$ , let  $E_\tau$  be the set of points flow backwards from the section  $\tau(B)$  union  $B \times \{-1\}$  (just as  $E_\nu$  was defined). Hence  $B \times [-1, 1]$  is the union of  $E_\tau, H_\tau$  and the intersection of  $E_\tau, H_\tau$  is equal to  $\tau(B)$ . Notice that

$$\mathcal{D} \times [-1, 1] - A \subset \left( \bigcup_{1 \leq i \leq i_0} V_{l_i} \right) \cup E_\tau$$

Choose leaves  $l_i$  close enough to  $l$  so that the length of any segment of  $\widetilde{\Lambda}^u \cap \tau(B)$  from  $\tau(l_i)$  to  $\tau(l_j)$  is very small. This yields a smaller neighborhood of  $y$  ( $V_{l_i}$  is bigger) and we show that the complement of this neighborhood of  $y$  goes near  $x$  under  $\gamma_n$ . For any  $i$ , the endpoints of  $\gamma_n(l_i)$  converge to a single point in  $\varphi^{-1}(x)$  as  $n \rightarrow \infty$ . Hence  $\gamma_n(l_i)$  also does and so  $\gamma_n(V_{l_i})$  gets very near  $\varphi^{-1}(x) \times [-1, 1]$  in  $\mathcal{D} \times [-1, 1]$ .

In order to finish the proof in case 2.b we need to analyse  $\gamma_n(E_\tau)$ . We modify the leaves  $s_j$  to be close enough to  $s$ , and the leaves  $t_j$  to be close enough to  $b_j$  and extend the section  $\nu(B')$  so that any unstable segment in  $\nu(B')$  connecting  $t_j \times \mathbf{R}$  to  $t_k \times \mathbf{R}$  has very large length. This decreases the set  $D$ , so we still have  $D \subset \eta^{-1}(U)$ .

Up to subsequence suppose there are  $z'_n$  in  $E_\tau$  so that  $\gamma_n(z'_n)$  are not in  $D$ . If  $c$  is an ideal point of  $r_i$  in  $\partial\mathcal{O}$ , then  $\gamma_n(c)$  converges to a point in  $\varphi^{-1}(x)$  in  $\partial\mathcal{O}$ . Let  $C_n$  be the closed, connected region in  $\mathcal{D}$  bounded by the union of the  $\gamma_n(r_i)$ ,  $1 \leq i \leq i_0$  union its ideal points. Then  $\gamma_n(z'_n)$  is in  $C_n \times [-1, 1]$ . The bottom of this set is  $C_n \times \{-1\}$  which is contained in  $D$  for  $n$  big. Hence if  $\gamma_n(z'_n)$  is not in  $D$  the following happens: First  $\gamma_n(z'_n)$  is in  $B' \times (-1, 1)$ , in particular  $\gamma_n(z'_n)$  is in  $\widetilde{M} = \mathcal{O} \times (-1, 1)$ . Second, as  $\gamma_n(z'_n)$  is not in  $E_\nu$  then  $\gamma_n(z'_n)$  is flow forward from a point in  $\nu(B')$ . As  $z'_n \in E_\tau$ , flow  $z'_n$  forward to a point  $z_n$  in the section  $\tau(B)$ . Hence  $\gamma_n(z_n)$  is still flow forward of a point in  $\nu(B')$ .

Now consider the segment  $v_n$  which is the intersection of  $\widetilde{W}^u(z_n)$  with the section  $\tau(B)$ . By construction this segment has arbitrarily small length and hence so does the segment  $\gamma_n(v_n)$  in  $\widetilde{W}^u(\gamma_n(z_n))$  – because  $\gamma_n$  acts as an isometry on  $\widetilde{M}$ . This segment  $\gamma_n(v_n)$  is entirely flow forward of  $\nu(B')$ . Flow  $\gamma_n(v_n)$  backwards until it hits the section  $\nu(B')$ . The unstable length gets decreased when flowing backwards or at least it does not increase too much, so it is a small length.

The segment  $v_n$  has endpoints in  $l_i \times \mathbf{R}$  and  $l_j \times \mathbf{R}$  for some  $i, j$ . The endpoints of  $\gamma_n(v_n)$  are in  $G_i = \gamma_n(l_i \times \mathbf{R})$  and  $G_j = \gamma_n(l_j \times \mathbf{R})$  which, for  $n$  sufficiently big, are contained in the union of  $V_{t_k}$ ,  $1 \leq k \leq j_0$ . Notice that the boundary of  $V_{t_k}$  is the stable leaf  $t_k \times \mathbf{R}$ . If both  $G_i$  and  $G_j$  are contained in the same  $V_{t_k}$  this forces  $\gamma_n(l_i)$  to be contained in  $V_{t_k}$  because its endpoints are in this set and an unstable leaf cannot intersect the stable leaf boundary more than once. But then  $\gamma_n(z'_n)$  is in  $D$  and we finish the analysis. The remaining possibility is that  $G_i$  is in some  $V_{t_k}$  and  $G_j$  is in some  $V_{t_m}$  with  $j \neq m$ . Therefore  $\gamma_n(v_n)$  flows back to a segment which has a subsegment from  $t_k \times \mathbf{R}$  to  $t_m \times \mathbf{R}$  in  $\nu(B')$ . This subsegment has fairly small length and this contradicts the choice of leaves  $\{s_j, t_j, 1 \leq j \leq j_0\}$  and the section  $\nu$ . This shows that  $\gamma_n(z'_n)$  are in  $D$  contradiction to assumption.

This shows that  $\gamma_n(E_\tau)$  is contained in  $D \subset \eta^{-1}(W)$ . Hence in  $\widetilde{M} \cup \mathcal{R}$ , the sets  $\gamma_n(\widetilde{M} \cup \mathcal{R} - \{y\})$  converge locally uniformly to  $x$ . This finishes the analysis of case 2.b and hence finishes the proof that  $\pi_1(M)$  acts as a convergence group on  $\widetilde{M} \cup \mathcal{R}$ .  $\square$

## 5 Connections with Gromov hyperbolicity

In this section we relate the flow ideal boundary and compactification with the large scale geometry of  $\widetilde{M}$  and Gromov hyperbolic spaces. Bowditch [Bo1], following ideas of Gromov, gave a topological characterization of the action of a hyperbolic group on its ideal boundary.

**Theorem 5.1.** (*Bowditch [Bo1]*) *Suppose that  $X$  is a perfect, metrisable compactum. Suppose that a group  $\Gamma$  acts on  $X$ , such that the induced action on the space of distinct triples is properly discontinuous and cocompact. Then  $\Gamma$  is a hyperbolic group. Moreover there is a natural  $\Gamma$ -equivariant homeomorphism of  $X$  into  $\partial\Gamma$ , where  $\partial\Gamma$  is the Gromov ideal boundary of  $\Gamma$ .*

The  $\Gamma$ -equivariant homeomorphism  $\alpha : X \rightarrow \partial\Gamma$  satisfies: if  $f$  is an element of  $\Gamma$  and  $a$  is the attracting fixed point of the action of  $f$  in  $X$ , then  $\alpha(a)$  is the attracting fixed point of the action of  $f$  in  $\partial\Gamma$ . In our situation  $X = \mathcal{R}$  and  $\Gamma = \pi_1(M)$ , which acts on  $X$ .

If  $\pi_1(M^3)$  is Gromov hyperbolic, Gromov also showed that  $\widetilde{M}$  has a compactification with an ideal boundary [Gr, Gh-Ha, CDP]. It is equivariantly homeomorphic to the Gromov boundary of  $\pi_1(M)$ , which is denoted by  $S_\infty^2$ . The following is now an immediate consequence of theorem 4.12.

**Theorem 5.2.** *Let  $\Phi$  be a pseudo-Anosov flow without perfect fits and not conjugate to a suspension Anosov flow. Let  $\mathcal{R}$  be the flow ideal sphere. Theorem 4.12 shows that  $\pi_1(M^3)$  acts as a uniform convergence group on  $\mathcal{R}$ . Bowditch's theorem implies that  $\pi_1(M)$  is Gromov hyperbolic and the action of  $\pi_1(M)$  on  $\mathcal{R}$  is topologically conjugate to the action of  $\pi_1(M)$  on the Gromov ideal boundary  $S_\infty^2$  of  $\widetilde{M}$ .*

Let  $\zeta : \mathcal{R} \rightarrow S_\infty^2$  be the conjugacy given by theorem 5.2. It is uniquely defined.

In addition to theorem 5.2 we also prove that the group equivariant compactification  $\widetilde{M} \cup \mathcal{R}$  is equivariantly homeomorphic to the Gromov compactification of  $\widetilde{M}$ . First we define a bijection

$$\xi : \widetilde{M} \cup \mathcal{R} \rightarrow \widetilde{M} \cup S_\infty^2 \quad - \quad \text{if } x \in \widetilde{M} \text{ let } \xi(x) = x, \quad \text{if } x \in \mathcal{R} \text{ let } \xi(x) = \zeta(x)$$

Clearly this map  $\xi$  is group equivariant: if  $\gamma$  is in  $\pi_1(M)$  then  $\xi(\gamma(x)) = \gamma(\xi(x))$ .

**Theorem 5.3.** *The map  $\xi : \widetilde{M} \cup \mathcal{R} \rightarrow \widetilde{M} \cup S_\infty^2$  is a group equivariant homeomorphism. The map  $\varphi_1 = \xi \circ \varphi : \partial\mathcal{O} \rightarrow S_\infty^2$  is a group invariant Peano curve.*

*Proof.* We only need to show that  $\xi$  is a homeomorphism. We know that  $\widetilde{M}$  is open in both  $\widetilde{M} \cup \mathcal{R}$  and in  $\widetilde{M} \cup S_\infty^2$  and the induced topology from both of these is the original topology of  $\widetilde{M}$ . Hence  $\xi$  is continuous in  $\widetilde{M}$ . Let  $x$  in  $\mathcal{R}$ . Lemma 4.17 showed that  $\widetilde{M} \cup \mathcal{R}$  is first countable. Hence to check continuity of  $\xi$  at  $x$  we only need to verify what happens for sequences. Let then  $p_n$  in  $\widetilde{M} \cup \mathcal{R}$  converging to  $x$  as  $n$  converges to infinity. Theorem 5.2 shows that  $\xi$  restricted to  $\mathcal{R}$  is continuous. Hence we may assume that  $p_n$  is in  $\widetilde{M}$ . Then there are  $q_n$  in a fixed compact set in  $\widetilde{M}$  and  $\gamma_n$  in  $\pi_1(M)$  with  $\gamma_n(q_n) = p_n$ . We may assume that the  $\gamma_n$  are distinct otherwise up to subsequence all  $\gamma_n = \gamma$  and  $\gamma_n$  sends  $q_n$  into a fixed compact set, contradiction.

By the convergence group action of  $\pi_1(M)$  on  $\widetilde{M} \cup \mathcal{R}$  (theorem 4.18), there is a source/sink pair  $y, z$  for some subsequence of  $(\gamma_n)$  (still denoted  $(\gamma_n)$ ). Since  $\pi_1(M)$  also acts as a convergence group on  $\widetilde{M} \cup S_\infty^2$  [Fr, Ge-Ma], then for this subsequence there is another subsequence (denoted  $(\gamma_{n_i})$ ) with a source/sink pair  $b, a$  for the action in  $\widetilde{M} \cup S_\infty^2$ . As the action of  $\pi_1(M)$  on  $\mathcal{R}$  is equivariantly conjugate to the action on  $S_\infty^2$ , it follows that  $\xi(y) = b$  and  $\xi(z) = a$ . Now

$$p_{n_i} = \gamma_{n_i}(q_{n_i}) \text{ converges to } x \text{ in } \widetilde{M} \cup \mathcal{R}$$

with  $q_{n_i}$  in a fixed compact set of  $\widetilde{M}$ . It follows that  $x$  is the sink of the sequence  $(\gamma_{n_i})$  acting on  $\widetilde{M} \cup \mathcal{R}$ , so  $x = z$ .

Consider now the situation in  $\widetilde{M} \cup S_\infty^2$ . Here  $\xi(p_{n_i}) = \gamma_{n_i}(\xi(q_{n_i}))$  with  $q_{n_i}$  in a compact set of  $\widetilde{M}$ . Then  $\xi(q_{n_i})$  is in a compact set of  $\widetilde{M}$ . By the convergence group property of  $\pi_1(M)$  acting on  $\widetilde{M} \cup S_\infty^2$ , then up to subsequence we may assume that  $\gamma_{n_i}(\xi(q_{n_i}))$  converges to the sink  $a = \xi(z) = \xi(x)$ . This shows that for any sequence  $(p_n)$  converging to  $x$  in  $\widetilde{M} \cup \mathcal{R}$ , there is a subsequence  $(p_{n_i})_{i \in \mathbb{N}}$  with  $\xi(p_{n_i})$  converging to  $\xi(x)$  in  $\widetilde{M} \cup S_\infty^2$ . It follows that  $\xi$  is continuous at  $x$  and so  $\xi$  is continuous. Since  $\widetilde{M} \cup \mathcal{R}$  is compact and Hausdorff then  $\xi$  is a homeomorphism.

Using this fact the second statement follows from the fact that the map  $\varphi : \partial\mathcal{O} \rightarrow \mathcal{R}$  is group equivariant. This finishes the proof of the theorem.  $\square$

## 6 Quasigeodesic flows and quasi-isometric singular foliations

In the last two sections of the article we obtain geometric consequences for flows and foliations. A flow  $\Phi$  in a manifold  $N$  is quasigeodesic if in  $\widetilde{N}$ , distance along flow lines of  $\Phi$  is a bounded multiplicative distortion of ambient distance. Quasigeodesic flows are extremely useful [Th1, Gr, Ca-Th, Fe-Mo]. In this section we show that if  $\Phi$  is a pseudo-Anosov flow without perfect fits, then  $\Phi$  is quasigeodesic. This will produce new examples of quasigeodesic pseudo-Anosov flows. A foliation  $\mathcal{E}$  (singular or not) is quasi-isometric if distance along leaves of  $\mathcal{E}$  is a bounded multiplicative distortion of ambient distance in  $\widetilde{N}$ . This property is very important [Th1, Th2, Mor, Gr, Ca-Th, Fe5, Fe8]. We show that the stable/unstable foliations of pseudo-Anosov flows without perfect fits are quasi-isometric. These results are consequences of theorems 5.2, 5.3 and previous results. Notice that both properties are invariant under quasi-isometries: if  $\Phi$  is a quasigeodesic flow and  $\Phi'$  is topologically conjugate to  $\Phi$ , then  $\Phi'$  is also quasigeodesic. The same holds for the quasi-isometric property for foliations. A quasi-isometry is a map so that when lifted to the universal cover it is bi-lipschitz in the large.



**Theorem 6.1.** *Let  $\Phi$  be a pseudo-Anosov flow without perfect fits. Then  $\Phi$  is a quasigeodesic flow. In addition the foliations  $\Lambda^s, \Lambda^u$  are quasi-isometric foliations.*

*Proof.* Suppose first that  $\Phi$  is topologically conjugate to a suspension Anosov flow. If  $\Phi'$  is a suspension Anosov flow and  $M$  has the solv metric, then  $\tilde{\Phi}'$  is a flow by minimal geodesics and the stable and unstable foliations  $\tilde{\Lambda}^{s'}, \tilde{\Lambda}^{u'}$  are foliations by totally geodesic surfaces. Therefore  $\Phi$  is quasigeodesic and  $\tilde{\Lambda}^s, \tilde{\Lambda}^u$  are quasi-isometric foliations.

For the remainder of the proof assume that  $\Phi$  is not conjugate to a suspension Anosov flow. Since  $\Phi$  has no perfect fits, theorem 5.2 shows that  $\pi_1(M)$  is Gromov hyperbolic. We now show that  $\Phi$  is quasigeodesic. We will prove 3 topological properties of the flow lines in  $\tilde{M} \cup \mathcal{R}$  (and then transfer them to  $\tilde{M} \cup S_\infty^2$ ):

Property 1 – For each flow line  $\alpha$  of  $\tilde{\Phi}$  then it limits in a single point of  $\mathcal{R}$  denoted by  $\alpha_+$  and similarly for the backwards direction.

$\alpha$  can be seen as a vertical segment  $\{y\} \times (-1, 1)$  in  $\mathcal{D} \times [-1, 1]$  where  $y$  is in  $\mathcal{O}$ . Let  $q$  in  $\alpha$ . Let  $z = (y, 1)$  and let  $x = \varphi(z)$  a point in  $\mathcal{R}$ . We claim that  $x$  is the limit of  $\alpha$  in  $\tilde{M} \cup \mathcal{R}$ . Let  $g$  be the decomposition element of  $\partial(\mathcal{D} \times [-1, 1])$  associated to  $z$ . For any neighborhood  $U$  of  $x$  in  $\tilde{M} \cup \mathcal{R}$  there is a set type  $A = A(l_1, \dots, l_n, r_1, \dots, r_n, \tau)$  (definition 4.13) with  $A \subset \eta^{-1}(U)$ . The description of type (iii) in definition 4.13, shows that since  $z$  is in  $g$  any such set  $A$  as above contains  $\tilde{\Phi}_t(q)$  for all  $t$  bigger than some  $t_0$ . This shows that in  $\tilde{M} \cup \mathcal{R}$  the flow line  $\alpha$  forward converges to  $x$ .

Similarly let  $\alpha_-$  be the negative ideal point of  $\alpha$ . In fact for any  $q$  in  $\tilde{M}$  let  $\alpha = \tilde{\Phi}_{\mathbf{R}}(q)$  and define  $\mu_+(q) = \alpha_+$  and  $\mu_-(q) = \alpha_-$ . This defines functions  $\mu_+, \mu_- : \tilde{M} \rightarrow \mathcal{R}$ .

Property 2 – For each flow line  $\alpha$  of  $\tilde{\Phi}$ , then the ideal points  $\alpha_+, \alpha_-$  are distinct.

Let  $\alpha$  be an orbit of  $\tilde{\Phi}$  which is  $\{y\} \times (-1, 1)$  for some  $y$  in  $\partial\mathcal{O}$ . Suppose that  $(y, 1), (y, -1)$  project to the same point in  $\mathcal{R}$ . By the construction of theorem 4.3, if a point in  $\mathcal{D} \times 1$  is identified to a point in  $\mathcal{D} \times \{-1\}$  then at least one of them has to be in  $\partial\mathcal{O} \times [-1, 1]$ . Since  $y$  is in  $\mathcal{O}$ , this is not the case here. Therefore  $\alpha_+, \alpha_-$  are distinct in  $\mathcal{R}$ .

Property 3 – The endpoint functions  $\mu_+, \mu_- : \tilde{M} \rightarrow \mathcal{R}$  are continuous.

Given  $p$  in  $\tilde{M}$ ,  $p$  is in  $\{y\} \times (-1, 1)$  for some  $y$  in  $\mathcal{O}$ . For any neighborhood  $U$  of  $\mu_+(p)$  then  $\eta^{-1}(U)$  contains a set of type  $A(l_1, \dots, l_n, r_1, \dots, r_n, \tau)$ . By the description of neighborhoods in definition 4.13, then for any  $q$  sufficiently near  $p$  then the forward orbit of  $q$  is eventually in  $A(l_1, \dots, l_n, r_1, \dots, r_n, \tau)$  and so  $\mu_+(q)$  is in  $U$ . This shows continuity of the map  $\eta_+$  at  $x$ .

Since the map  $\xi : \tilde{M} \cup \mathcal{R} \rightarrow \tilde{M} \cup S_\infty^2$  is a homeomorphism then as seen in  $\tilde{M} \cup S_\infty^2$  properties 1) through 3) also hold for orbits of  $\tilde{\Phi}$ . This is the key fact here: properties in  $\tilde{M} \cup \mathcal{R}$  get transferred to  $\tilde{M} \cup S_\infty^2$ . We now use a result of Fenley-Mosher [Fe-Mo] which states that if  $\pi_1(M)$  is Gromov hyperbolic and properties 1) through 3) hold for orbits of a flow  $\Phi$  then  $\Phi$  is a uniform quasigeodesic flow. Hence  $\Phi$  is a quasigeodesic flow.

We now prove that  $\Lambda^s, \Lambda^u$  are quasi-isometric singular foliations. Given that  $\Phi$  is a quasigeodesic pseudo-Anosov flow, then it was proved in [Fe5], theorem 3.8, that  $\Lambda^s$  is quasi-isometric if and only if  $\tilde{\Lambda}^s$  has Hausdorff leaf space and similarly for  $\Lambda^u$ . Suppose that  $\tilde{\Lambda}^s$  does not have Hausdorff leaf space and let  $F, L$  not separated in  $\tilde{\Lambda}^s$ . Theorem 2.6 shows that  $F, L$  are connected by a chain of lozenges. A lozenge has 2 perfect fits – which are disallowed by hypothesis. Hence  $\Lambda^s, \Lambda^u$  are quasi-isometric foliations. This finishes the proof of theorem 6.1.  $\square$

## 7 Asymptotic properties of foliations

Here we show that  $\mathbf{R}$ -covered foliations and foliations with one sided branching in atoroidal manifolds are transverse to pseudo-Anosov flows without perfect fits and therefore satisfy the continuous extension

property. This parametrizes and characterizes their limit sets. In addition this shows that pseudo-Anosov flows without perfect fits are very common.

**Theorem 7.1.** *Let  $\mathcal{F}$  be a Reebless  $\mathbf{R}$ -covered foliation in  $M^3$  closed, atoroidal and not finitely covered by  $\mathbf{S}^2 \times \mathbf{S}^1$ . Then  $\pi_1(M)$  is Gromov hyperbolic and  $\mathcal{F}$  satisfies the continuous extension property. This produces new examples of group invariant Peano curves.*

*Proof.* Up to a double cover, we may assume that  $\mathcal{F}$  is transversely orientable. Recall that  $\mathbf{R}$ -covered means that the leaf space of  $\tilde{\mathcal{F}}$  is homomorphic to the reals  $\mathbf{R}$ . If  $\mathcal{F}$  is  $\mathbf{R}$ -covered and  $M$  is not finitely covered by  $\mathbf{S}^2 \times \mathbf{S}^1$ , then it was proved in [Fe6, Cal2] that either there is a  $\mathbf{Z} \oplus \mathbf{Z}$  subgroup of  $\pi_1(M)$  or there is a pseudo-Anosov flow  $\Phi$  transverse to  $\mathcal{F}$  and regulating for  $\mathcal{F}$ . Since  $M$  is (homotopically) atoroidal the second option occurs. Regulating means that every orbit of  $\Phi$  intersects an arbitrary leaf of  $\tilde{\mathcal{F}}$  and vice versa. Therefore the orbit space of  $\Phi$  can be identified to the set of points in a leaf  $F$  of  $\tilde{\mathcal{F}}$ . Using Candel's theorem [Ca] we can assume that all leaves of  $\mathcal{F}$  are hyperbolic. In this situation the set  $\mathcal{D} = \mathcal{O} \cup \partial\mathcal{O}$  is naturally identified to the compactification of  $F$  with a circle at infinity  $\partial_\infty F$ . Here is why: The construction of  $\Lambda^s, \Lambda^u$  in [Fe5, Cal2] is obtained by blowing down 2 transverse laminations which intersect the leaves of  $\mathcal{F}$  in geodesics. Therefore there are 2 geodesic laminations (stable and unstable) in  $F$ , whose complementary regions are finite sided ideal polygons [Fe6, Cal2]. It follows that the ideal points of  $F$  are either ideal points of leaves of  $\tilde{\Lambda}^s \cap F, \tilde{\Lambda}^u \cap F$  or have neighborhood systems defined by leaves of these. Hence  $\partial_\infty F$  is naturally homeomorphic to  $\partial\mathcal{O}$  and  $F \cup \partial_\infty F$  is homeomorphic to  $\mathcal{O} \cup \partial\mathcal{O}$ . This works for any  $F$  in  $\tilde{\mathcal{F}}$ .

Suppose there is a perfect fit between a leaf  $L$  of  $\tilde{\Lambda}^s$  and a leaf  $H$  of  $\tilde{\Lambda}^u$ . Then in  $\mathcal{O}$  there are rays of  $\Theta(L), \Theta(H)$  defining the same ideal point in  $\partial\mathcal{O}$ . By the above description there is a pair of geodesics in  $F$ , one stable and one unstable with the same ideal point in  $\partial_\infty F$ . By hyperbolic geometry considerations these 2 geodesics are asymptotic in  $F$ , so projecting to  $M$  and taking limits we obtain a leaf of  $\mathcal{F}$  so that there is a geodesic which is a leaf of both the stable and unstable laminations. This contradicts the fact that the stable and unstable laminations are transverse.

It follows that  $\Phi$  has no perfect fits. By theorem 5.2 it follows that  $\pi_1(M)$  is Gromov hyperbolic (this particular fact was already known, by the Gabai-Kazhdan theorem [Ga-Ka] and results in [Fe6, Cal2, Fe7]). By theorem 6.1 it follows that  $\Phi$  is a quasigeodesic pseudo-Anosov flow and in addition the map  $\varphi_1 : \partial\mathcal{O} \rightarrow S_\infty^2$  is a group equivariant Peano curve. The previously known examples of such group invariant Peano curves occurred for fibrations [Ca-Th] and slitherings by work of Thurston [Th5]. The results here are useful because Calegari [Cal1], showed that there are many examples of  $\mathbf{R}$ -covered foliations in hyperbolic 3-manifolds which are not slitherings or uniform foliations. The results here imply the previous results for fibrations and slitherings.

Now we analyse the continuous extension property for the leaves of  $\tilde{\mathcal{F}}$ . Since  $\Phi$  is quasigeodesic and transverse to  $\mathcal{F}$ , then the main theorem in [Fe8] implies that leaves of  $\tilde{\mathcal{F}}$  extend continuously to  $S_\infty^2$ . Hence  $\mathcal{F}$  has the continuous extension property. This finishes the proof of theorem 7.1. We remark that there is a direct proof of the continuous extension property in this case since  $\partial\mathcal{O}$  is naturally identified to  $\partial_\infty F$ . For simplicity we just quote the result of [Fe8]. Notice that the leaves of  $\tilde{\mathcal{F}}$  have limit set the whole sphere, so each leaf  $F$  of  $\tilde{\mathcal{F}}$  produces a sphere filling curve.  $\square$

We now turn to foliations with one sided branching.

**Theorem 7.2.** *Let  $\mathcal{F}$  be a Reebless foliation with one sided branching in  $M^3$  closed, atoroidal and not finitely covered by  $\mathbf{S}^2 \times \mathbf{S}^1$ . Then  $\pi_1(M)$  is Gromov hyperbolic. There is a pseudo-Anosov flow  $\Phi$  transverse to  $\mathcal{F}$  which has no perfect fits and hence is a quasigeodesic flow and its stable/unstable foliations are quasi-isometric. It follows that  $\mathcal{F}$  has the continuous extension property.*

*Proof.* Recall that  $\mathcal{F}$  has one sided branching if the leaf space of  $\tilde{\mathcal{F}}$  is not Hausdorff, but the non Hausdorff behavior occurs only in (say) the negative direction. Since  $\mathcal{F}$  has one sided branching it is transversely oriented. Suppose that  $\tilde{\mathcal{F}}$  has branching only in the negative direction. When  $M$  is atoroidal and not

finitely covered by  $\mathbf{S}^2 \times \mathbf{S}^1$ , Calegari [Cal3] produced a pseudo-Anosov flow  $\Phi$  which is transverse to  $\mathcal{F}$  and forward regulating for  $\mathcal{F}$ . Forward regulating means that if  $x$  is in a leaf  $F$  of  $\tilde{\mathcal{F}}$  and  $L$  is a leaf of  $\tilde{\mathcal{F}}$ , for which there is a positive transversal from  $F$  to  $L$ , then the forward orbit of  $x$  intersects  $L$ .

As in the  $\mathbf{R}$ -covered case this is obtained from 2 laminations transverse to  $\mathcal{F}$  which intersect the leaves of  $\tilde{\mathcal{F}}$  in a collection of geodesics. Suppose there is  $G$  in  $\tilde{\Lambda}^s$  and  $H$  in  $\tilde{\Lambda}^u$  forming a perfect fit. Then  $G$  intersects  $F_0$  leaf of  $\tilde{\mathcal{F}}$  and  $H$  intersects  $F_1$ . Since  $\mathcal{F}$  has one sided branching there is a leaf  $F$  of  $\tilde{\mathcal{F}}$  with positive transversals from  $F_0$  to  $F$  and from  $F_1$  to  $F$ . By the above property  $G$  and  $H$  intersect  $F$ . There are rays in  $\Theta(G)$  and  $\Theta(H)$  with same ideal point  $p$  in  $\partial\mathcal{O}$ .

The ideal circle of  $\mathcal{O}$  is the same as the universal circle for the foliation  $\mathcal{F}$  in this case [Cal3]. The universal circle is obtained as the inverse limit of circles at infinity escaping in the positive direction. Given  $A, B$  leaves of  $\tilde{\mathcal{F}}$  we write  $A < B$  if there is a positive transversal from  $A$  to  $B$ . Given  $A < B$  in  $\tilde{\mathcal{F}}$  then there is a dense set of directions in  $A$  which are asymptotic to  $B$  [Cal3]. This is not symmetric – there is not a dense set of directions from  $B$  which is asymptotic to  $A$ . In our situation with  $F_0 < F$  and  $F_1 < F$  then the asymptotic directions from  $F$  to  $F_0$  form an unlinked set with the asymptotic directions from  $F$  to  $F_1$  [Cal1, Cal3]. This implies there are natural surjective, continuous, weakly circularly monotone maps  $\partial_\infty F \rightarrow \partial_\infty F_i$ . The universal circle  $\mathcal{V}$  is obtained as an inverse limit of these maps.

The stable/unstable laminations are obtained by analysing the action of  $\pi_1(M)$  in  $\mathcal{V}$  and producing laminations – that is, a collection of pairs of points in  $\mathcal{V}$  which are unlinked. They produce a collection of geodesics in leaves of  $\tilde{\mathcal{F}}$ , without transverse intersections, which vary continuously in the transversal direction. Therefore if rays of  $\Theta(G), \Theta(H)$  define the same ideal point in  $\partial\mathcal{O}$ , then in the leaf  $F$  which they jointly intersect the following happens: the associated stable/unstable geodesics are asymptotic. As in the  $\mathbf{R}$ -covered case this leads to a contradiction to  $\tilde{\Lambda}^s, \tilde{\Lambda}^u$  being transverse.

We conclude that  $\Phi$  has no perfect fits. From this point on the proof follows the same arguments as in the  $\mathbf{R}$ -covered case. □

**Corollary 7.3.** *Let  $\mathcal{F}$  be a Reebless foliation with one sided branching in  $M^3$  atoroidal and not finitely covered by  $\mathbf{S}^2 \times \mathbf{S}^1$ . For any leaf  $F$  of  $\tilde{\mathcal{F}}$ , then the limit set of  $F$  is not the whole sphere  $S_\infty^2$ .*

*Proof.* The limit set of a set  $B$  in  $\tilde{M}$  is the set of accumulation points of  $B$  in  $S_\infty^2$ . Suppose that there is branching of  $\tilde{\mathcal{F}}$  only in the negative direction. Choose  $E, L$  non separated from each other and so that  $F < E$ . Branching in the negative direction means that there is a sequence of leaves  $(G_n)$  on the positive side of  $E, L$  which converges to both  $E, L$ . Since  $E, L$  are non separated from each other, then they do not intersect the same orbit of  $\tilde{\Phi}$ . Recall the projection map  $\Theta : \tilde{M} \rightarrow \mathcal{O}$ . The sets  $\Theta(E), \Theta(L)$  are disjoint. Since  $E, L$  are non separated from each other in their positive sides, then the analysis in section 4 of [Fe8], shows that there is a slice leaf  $S$  of a unstable leaf of  $\tilde{\Lambda}^s$ , so that  $s = \Theta(S)$  is a boundary component of  $\Theta(L)$  and  $s$  separates  $\Theta(L)$  from  $\Theta(E)$ .

Then the limit set of  $S, \Lambda_S$  is a Jordan curve  $C$  – this is shown in [Fe1, Fe5]. This uses the fact that  $\Lambda^s$  is a quasi-isometric foliation. The construction implies that the leaf  $E$  separates  $F$  from  $S$  – here we use that  $E, L$  are non separated from each other on their positive sides and  $F$  is in the back of  $E$ . Since  $S$  is disjoint from  $F$  then the limit set of  $F$  is contained in the closure of one complementary component of  $\Lambda_S$  in  $S_\infty^2$ . Therefore  $\Lambda_F$  is not  $S_\infty^2$ . □

**Remarks –**

1) The remaining open situation for the continuous extension property is that of  $\mathcal{F}$  with two sided branching. This means that the leaf space of  $\tilde{\mathcal{F}}$  has non Hausdorff behavior in both the positive and negative directions. The particular case of finite depth foliations was recently solved in [Fe8] using completely different methods than this article. In particular in [Fe8] one starts with strong geometric properties, namely that  $M$  is hyperbolic and there is a leaf which is quasi-isometrically embedded (the compact leaf) and this has enormous geometric consequences. The tools here are purely from dynamical systems.

2) Many  $\mathbf{R}$ -covered examples in hyperbolic 3-manifolds which are not slitherings were constructed by Calegari in [Cal1]. Many explicit examples of foliations with one sided branching were constructed by Meigniez in [Me].

3) Suppose that  $\mathcal{F}$  is Reebless in  $M^3$  with  $\pi_1(M)$  negatively curved. It is asked in [Fe3, Fe8]: is  $\mathcal{F}$   $\mathbf{R}$ -covered if and only if for some  $F$  in  $\tilde{\mathcal{F}}$  then the limit set  $\Lambda_F = S_\infty^2$ ? If  $\mathcal{F}$  is  $\mathbf{R}$ -covered then  $\Lambda_F = S_\infty^2$  for every  $F$  in  $\tilde{\mathcal{F}}$  [Fe3]. The converse is true if there is a compact leaf in  $\mathcal{F}$  [Go-Sh, Fe3]. The previous theorem shows that if  $\mathcal{F}$  has one sided branching then  $\Lambda_F$  is not  $S_\infty^2$  for any  $F$  in  $\tilde{\mathcal{F}}$ . Therefore the remaining open case for this question is also when  $\mathcal{F}$  has 2 sided branching.

4) The results of this article show that foliations in manifolds with Gromov hyperbolic fundamental group are very similar to surface Kleinian groups: the  $\mathbf{R}$ -covered case corresponds to doubly degenerate surface Kleinian groups, where the limit sets are the whole sphere. The foliations with one sided branching correspond to singly degenerate Kleinian groups where there is a single component of the domain of discontinuity. It remains to be seen whether foliations with 2 sided branching behave like non degenerate surface Kleinian groups.

## References

- [Ba1] T. Barbot, *Caractérisation des flots d'Anosov pour les feuilletages*, Erg. Th. Dyn. Sys. **15** (1995) 247-270.
- [Ba2] T. Barbot, *Mise en position optimale de tores par rapport à un flot d'Anosov*, Comm. Math. Helv. **70** (1995) 113-160.
- [Ba3] T. Barbot, *Actions de groupes sur les 1-variétés non séparées et feuilletages de codimension un*, Ann. Fac. Sci. Toulouse Math. **7** (1998) 559-597.
- [Be-Fe] M. Bestvina and M. Feighn, *A combination theorem for negatively curved groups*, Jour. Diff. Geom. **35** (1992) 85-101.
- [Be-Me] M. Bestvina and G. Mess, *The boundary of negatively curved groups*, Jour. Amer. Math. Soc. **4** (1991) 469-481.
- [Bl-Ca] S. Bleiler and A. Casson, *Automorphisms of surfaces after Nielsen and Thurston*, Cambridge Univ. Press, 1988.
- [Bo-La] C. Bonatti and R. Langevin, *Un exemple de flot d'Anosov transitif transverse à un tore et non conjugué à une suspension*, Erg. Th. Dyn. Sys. **14** (1994) 633-643.
- [Bo1] B. Bowditch, *A topological characterization of hyperbolic groups*, Jour. A.M.S. **11** (1998) 643-667.
- [Bo2] B. Bowditch, *Convergence groups and configuration spaces*, in "Group Theory Down Under", Ed. J. Cossey, C.F. Miller, W.D. Newmann, M. Shapiro, 23-54 de Gruyter Berlin 1999.
- [Cal1] D. Calegari,  *$\mathbf{R}$  covered foliations of hyperbolic 3-manifolds*, Geom. Topol. **3** (1999) 137-153.
- [Cal2] D. Calegari, *The geometry of  $\mathbf{R}$ -covered foliations*, Geom. Topol. **4** (2000) 457-515.
- [Cal3] D. Calegari, *Foliations with one-sided branching*, Geom. Ded. **96** (2003) 1-53.
- [Cal4] D. Calegari, *Promoting essential laminations*, Inven. Math. **166** (2006) 583-643.
- [Ca-Du] D. Calegari and N. Dunfield, *Laminations and groups of homeomorphisms of the circle*, Inven. Math. **152** (2003) 149-204.
- [Ca] A. Candel, *Uniformization of surface laminations*, Ann. Sci. Ecole Norm. Sup. **26** (1993) 489-516.
- [Ca-Sw] J. Cannon and E. Swenson, *Recognizing constant curvature discrete groups in dimension 3*, Trans. A.M.S. **350** (1998) 809-849.
- [Ca-Th] J. Cannon and W. Thurston, *Group invariant Peano curves*, Geom. Top. **11** (2007) 1315-1355.
- [Ca-Ju] A. Casson and D. Jungreis, *Convergence groups and Seifert fibered 3-manifolds*, Inven. Math. **118** (1994) 441-456.
- [CDP] M. Coornaert, T. Delzant and A. Papadopoulos, *Géométrie and théorie des groupes, Les groupes hyperboliques de Gromov*, Lec. Notes in Math **1441** Springer (1991).
- [FLP] A. Fathi, F. Laudenbach and V. Poenaru, *Travaux de Thurston sur les surfaces*, Astérisque **66-67**, Soc. Math. France, 1979.
- [Fe1] S. Fenley, *Anosov flows in 3-manifolds*, Ann. of Math. **139** (1994) 79-115.
- [Fe2] S. Fenley, *Quasigeodesic Anosov flows and homotopic properties of flow lines*, Jour. Diff. Geom. **41** (1995) 479-514.
- [Fe3] S. Fenley, *Limit sets of foliations*, Topology **37** (1998) 875-894.
- [Fe4] S. Fenley, *The structure of branching in Anosov flows of 3-manifolds*, Comm. Math. Helv. **73** (1998) 259-297.
- [Fe5] S. Fenley, *Foliations with good geometry*, Jour. Amer. Math. Soc. **12** (1999) 619-676.
- [Fe6] S. Fenley, *Foliations, topology and geometry of 3-manifolds:  $\mathbf{R}$ -covered foliations and transverse pseudo-Anosov flows*, Comm. Math. Helv. **77** (2002) 415-490.
- [Fe7] S. Fenley, *Pseudo-Anosov flows and incompressible tori*, Geom. Ded. **99** (2003) 61-102.

- [Fe8] S. Fenley, *Geometry of foliations and flows I: Almost transverse pseudo-Anosov flows and asymptotic behavior of foliations*, Jour. Diff. Geom. **81** (2009) 1-89.
- [Fe-Mo] S. Fenley and L. Mosher, *Quasigeodesic flows in hyperbolic 3-manifolds*, Topology **222** (2001) 503-537.
- [Fr-Wi] J. Franks and R. Williams, *Anomalous Anosov flows*, in Global Theory of Dyn. Sys., Lec.Notes Math. **819**, Springer, 1980.
- [Fr] E. Freden, *Negatively curved groups have the convergence property*, Ann. Acad. Sci.Fenn. Ser. A. Math. **20** (1995) 333-348.
- [Ga1] D. Gabai, *8 problems in foliations and laminations*, in Geometric Topology, W. Kazez, ed., Amer. Math. Soc. 1987, 1-33.
- [Ga2] D. Gabai, *Convergence groups are Fuchsian groups*, Ann. of Math. **136** (1992) 447-510.
- [Ga3] D. Gabai, *Quasi-minimal semi-Euclidean laminations in 3-manifolds*, Surveys in differential geometry, **III** (1996) 195-242.
- [Ga-Ka] D. Gabai and W. Kazez, *Group negative curvature for 3-manifolds with genuine laminations*, Geom. Top. **2** (1998) 65-77.
- [Ga-Oe] D. Gabai and U. Oertel, *Essential laminations and 3-manifolds*, Ann. of Math. **130** (1989) 41-73.
- [Ge-Ma] F. Gehring and G. Martin, *Discrete quasiconformal groups I*, Proc. London Math.Soc. bf 55 (1987) 331-358.
- [Gh-Ha] E. Ghys and P. De la Harpe, editors, *Sur les groupes hyperboliques d'après Mikhael Gromov*, Progress in Math. **83**, Birkhäuser, 1990.
- [Go-Sh] S. Goodman and S.Shields, *A condition for the stability of  $\mathbf{R}$ -covered foliations in 3-manifolds*, Trans. A.M.S. **352** (2001) 4051-4065.
- [Gr] M. Gromov, *Hyperbolic groups*, in Essays on Group theory, Springer-Verlag, 1987, pp. 75-263.
- [Han] M. Handel *Global shadowing pseudo-Anosov homeomorphisms* Erg. Th. Dyn. Sys. **5** (1985) 373-377.
- [He] J. Hempel, *3-manifolds*, Ann. of Math. Studies 86, Princeton University Press, 1976.
- [Ke] J. Kelley, *General Topology*, Graduate Texts in Mathematics, **27**, Springer, 1955.
- [Man] B. Mangum, *Incompressible surface and pseudo-Anosov flows*, Topol. Appl. **87** (1998) 29-51.
- [Me] G. Meigniez, *Bouts d'un groupe opérant sur la droite: 2. Applications á la topologie de feuilletages*, Tôhoku Math. Jour. **43** (1991) 473-500.
- [Mor] J. Morgan, *On Thurston's uniformization theorem for 3-dimensional manifolds*, in The Smith Conjecture, J. Morgan and H. Bass, eds., Academic Press, New York, 1984, 37-125.
- [Mo1] L. Mosher, *Dynamical systems and the homology norm of a 3-manifold II*, Invent. Math. **107** (1992) 243-281.
- [Mo2] L. Mosher, *Examples of quasigeodesic flows on hyperbolic 3-manifolds*, in Proceedings of the Ohio State University Research Semester on Low-Dimensional topology, W. de Gruyter, 1992.
- [Mo3] L. Mosher, *Laminations and flows transverse to finite depth foliations*, Part I: Branched surfaces and dynamics – available from <http://newark.rutgers.edu:80/mosher/>, Part II in preparation.
- [Mu] J. Munkres, *A first course in Topology*, Prentice Hall, 2000.
- [Ot1] J. P. Otal, *The hyperbolization theorem for fibered 3-manifolds*, SMF/AMS texts and monographs **7** 2001.
- [Ot2] J. P. Otal, *Thurston's hyperbolization theorem for Haken manifolds*, Surveys in differential geometry, **III** (1996) 77-194.
- [Pe1] G. Perelman, *The entropy formulat for the Ricci flow and its geometric applications*, eprint math.DG/0211159.
- [Pe2] G. Perelman, *Ricci flow with surgery on 3-manifolds*, eprint math.DG/0303109.
- [Pe3] G. Perelman, *Finite extinction time for the solutions to the Ricci flow in certain 3-manifolds*, eprint math arxiv math.DG/0307245.
- [Ro-St] R. Roberts and M. Stein, *Group actions on order trees*, Topol. Appl. **115** (2001) 175-201.
- [Th1] W. Thurston, *The geometry and topology of 3-manifolds*, Princeton University Lecture Notes, 1982.
- [Th2] W. Thurston, *Three dimensional manifolds, Kleinian groups and hyperbolic geometry*, Bull. A.M.S. **6** (1982) 357-381.
- [Th3] W. Thurston, *Hyperbolic structures on 3-manifolds II: Surface groups and 3-manifolds that fiber over the circle*, preprint.
- [Th4] W. Thurston, *On the geometry and dynamics of diffeomorphisms of surfaces*, Bull. A.M.S. **19** (1988) 417-431.
- [Th5] W. Thurston, *3-manifolds, foliations and circles I*, preprint.
- [Tu1] P. Tukia, *Homeomorphic conjugates of Fuchsian groups*, J. Reign Angew. Math. **391** (1988) 1-54.
- [Tu2] P. Tukia, *Convergence groups and Gromov's metric hyperbolic spaces*, New Zealand J. Math. **23** (1994) 157-187.
- [Tu3] P. Tukia, *Conical limit points and uniform convergence groups*, J. Reine Angew. Math. **501** (1998) 71-98.
- [Wa] F. Waldhausen, *On irreducible 3-manifolds which are sufficiently large*, Ann. of Math. **87** (1968) 56-88.
- [Wi] R. Wilder, *Topology of Manifolds*, A.M.S. Colloquium Publ. **32** (1949).